

HydraMaster

We've Got Your Back



Session 2

HydraMaster
We've Got Your Back



Made in the USA

www.hydramaster.com | 800.426.1301 | 425.775.7272

HydraMaster Truckmount Elevator Sales Speech "Cheat Sheet"

CDS DIRECT DRIVE

1. #1 selling direct drive truckmount in the world
2. Easy to operate and train – low maintenance
3. Leaves the most cargo room of any truckmount



CDS xDRIVE DIRECT DRIVE

1. Only direct drive that can go in a unibody van
2. Hybrid electronic technology
3. Rivals the power, heat, vacuum, and performance of the biggest slide-ins



TITAN 575

1. Relentless dual wand workhorse
2. Easy access magnetic panels
3. Liquid cooled 32.5HP Kubota engine for reliability and longevity



TITAN H2O

1. Purpose built for water extraction
2. No pressure/solution side reduces maintenance
3. Liquid cooled 32.5HP Kubota engine for reliability and longevity



TMTG4000 Truckmount to Go

1. The mobile truckmount that does not require a truck
2. Both extraction and cleaning capability
3. Automatic wastewater disposal system included



BOXXER XL

1. 31HP, 400+CFM, 240°F, 2 Wands = The numbers add up
2. Most economical true dual wand unit
3. In a class all by itself



TITAN 425

1. Sweet spot machine – more horsepower, more heat
2. Better heat control, less water dumping
3. Better air circulation – no belt cooling fans required



BOXXER 318HP

1. Up to 1500psi cleaning pressure for hard surface
2. Addresses reality of flooring marketplace
3. Stainless steel solution pump, high pressure heater coil
4. Hydra-Clutch plus high pressure – perfect for restoration



TITAN 325

1. Affordable value, radical performance – entry level, step up
1. Hydra-Clutch for water extraction
2. Easy maintenance with high level of reliability



HydraMaster warranty service is rated #1 by distributor mechanics!

"We've got your back"

HydraMaster
We've Got Your Back



Made in the USA

www.hydramaster.com | 800.426.1301 | 425.775.7272

Finding New Customers for Truckmounts



www.hydramaster.com | 800.426.1301 | 425.775.7272

Marketing Activities 2020 (Delivery Systems)



Single Truck Independent Contractor

Value Proposition: HydraMaster partners with owner-operators in the cleaning and restoration industry to provide reliable, high performing equipment that is easy to maintain. We provide best in class financing solutions that simplify the buying process and we continue to deliver world class technical and warranty support.



Strategic fit assessment

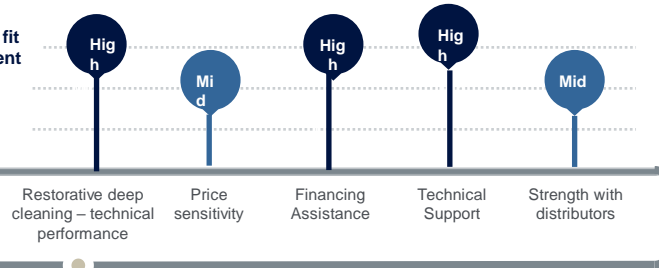

Personas

- One truck forever (lifestyle)
- Established company upgrading
- Gearhead
- Entry level

Decision



Purchase triggers

- Old equipment breaks down or growth demands expansion
- Upgrading to better equipment
- New technology that improves efficiency
- Love to try new toys (tools & accessories)



Cleaning characteristics

- Fast drying times
- Maximum appearance improvement
- Deep cleaning required in residential setting – maximum extraction and removal of contaminants, soiling, allergens, and bacteria
- Spot & stain removal/prevention from wicking back
- Pet urine contamination stain & odor removal

Main product drivers

- Vacuum Performance
- Temperature
- Reliability
- Price
- Ease of Maintenance

Main product application

- Restorative, deep extraction carpet cleaning
- Restorative, deep extraction tile & stone floor cleaning
- Water extraction – flood extraction
- Pressure washing

Trends

Diversifying into other floor cleaning, rug cleaning, and restoration, and low moisture carpet cleaning is growing exponentially

78% of revenue derived from residential cleaning

Market share of carpet market share in the flooring industry decreased by 30% from 2008-2015. Now holding steady but not growing

Percent who purchase major equipment through distribution remains steady at 80%

Owner-Operators continue to withstand larger corporations entering this service sector

Industry is getting older – millennials not entering service sector as career choice

Internet and direct buying growing for accessories and consumables

Franchise Segment

Value Proposition: HydraMaster helps propel the success of cleaning and restoration franchises whose proprietary processes are integrated into our innovative equipment to bring economical and efficient solutions to their franchisees. We do this by applying world class design and engineering expertise.



Strategic fit assessment

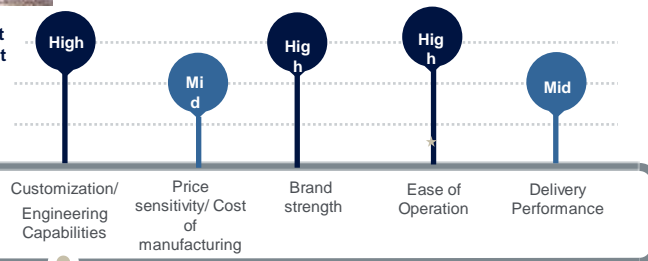

Personas

Franchise - Custom

Equipment. Customer proud of their unique cleaning technology. Looking for partners who can integrate with their proprietary approach to provide a differentiated solution.

Franchise - Standard

Equipment. Customer proud of unique business model to offer franchisees. Looking for business partners who can provide a high performing, cost effective standard solution, with unique branding. Example

2 **Decision**



30%

Make decision alone

70%

Consult with others (franchise/lead technician/spouse-partner)

The variability of franchises and how they buy can greatly depend upon the network and centralization of the franchise home office

Purchase triggers

- Franchise endorsement/approval
- New franchise opening
- Replacement of old equipment – expansion of existing business
- New technology from franchise or HydraMaster



Cleaning characteristics

- Integration into proprietary cleaning or extraction process of franchise
- Water and Flood extraction capabilities
- CRI SOA approval of system
- Safety of operation and solutions
- Maximum appearance improvement – fast drying times
- Deep cleaning in both residential and commercial settings – maximum extraction and removal of contaminants, soiling, allergens, and bacteria

Main product application

- Restorative, deep extraction cleaning of carpet & tile
- Water extraction – flood extraction
- Pressure washing
- High speed commercial deep cleaning of carpet

Main product drivers



- Customization
- Price
- Brand/Relationship
- Ease of Operation

Trends

Regulatory compliance getting more complex and more important to larger organizations

Second generation choosing alternative professions forcing larger, older companies to sell

Larger restoration companies moving from truckmounts back to portables

Diversification of service offerings

Internet and direct buying growing for accessories and consumables

Corporate Multi-Location Contract Cleaners -

Value Proposition: HydraMaster partners with facility maintenance providers who specialize in restorative deep cleaning of flooring to provide custom, easy to use total solutions from a proven cleaning and restoration equipment manufacturer. We continue to provide our customers with the industries best fleet solutions for more than 45 years.



Strategic fit assessment

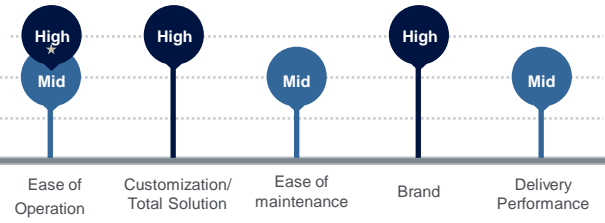

Personas

- Centralized Decision Making by corporate floor cleaning building services contractor
- Decentralized Decision Making

Purchase triggers

- Contract win / business extension
- Efficient performance promise and low cost
- Invest if saving time (labor) and/or optimizing productivity

Cleaning characteristics

- Unlike traditional Building Service Contractors who provide turn key total facility cleaning and maintenance solutions, we are targeting contractors who specialize in restorative, deep cleaning of carpet and hard surface floors.
- Cleaning should be done as efficient and productive as possible whilst still delivering an acceptable deep cleaning result aligned with the contract agreed
- With a high turnover of staff it is very important that cleaning equipment is easy to use to minimize need for costly training



Main product drivers

- Brand/Relationship
- Ease of operation
- Customization
- Technical Performance
- Ease of maintenance
- Delivery performance

Main product application

- High performance, restorative deep cleaning of carpeting and tile and stone floors.
- Water extraction. Restorative drying.
- Operation in noise sensitive environments
- Measured clean

Decision



- Products are often on trial to evaluate the performance

- Move towards low moisture/encapsulation systems for commercial carpet cleaning
- Growing demand for bundled service contracts as facility management
- Rise in specialized cleaning services directed at specific channels
- Budget cuts in both private and public sectors pressure costs

Trends

- Sustainability focus / environmental impact documentation required by esp. larger clients
- Increasing crossover from high performance residential market to class a commercial cleaning
- Bundled product application solutions

Fleet Independent Operators

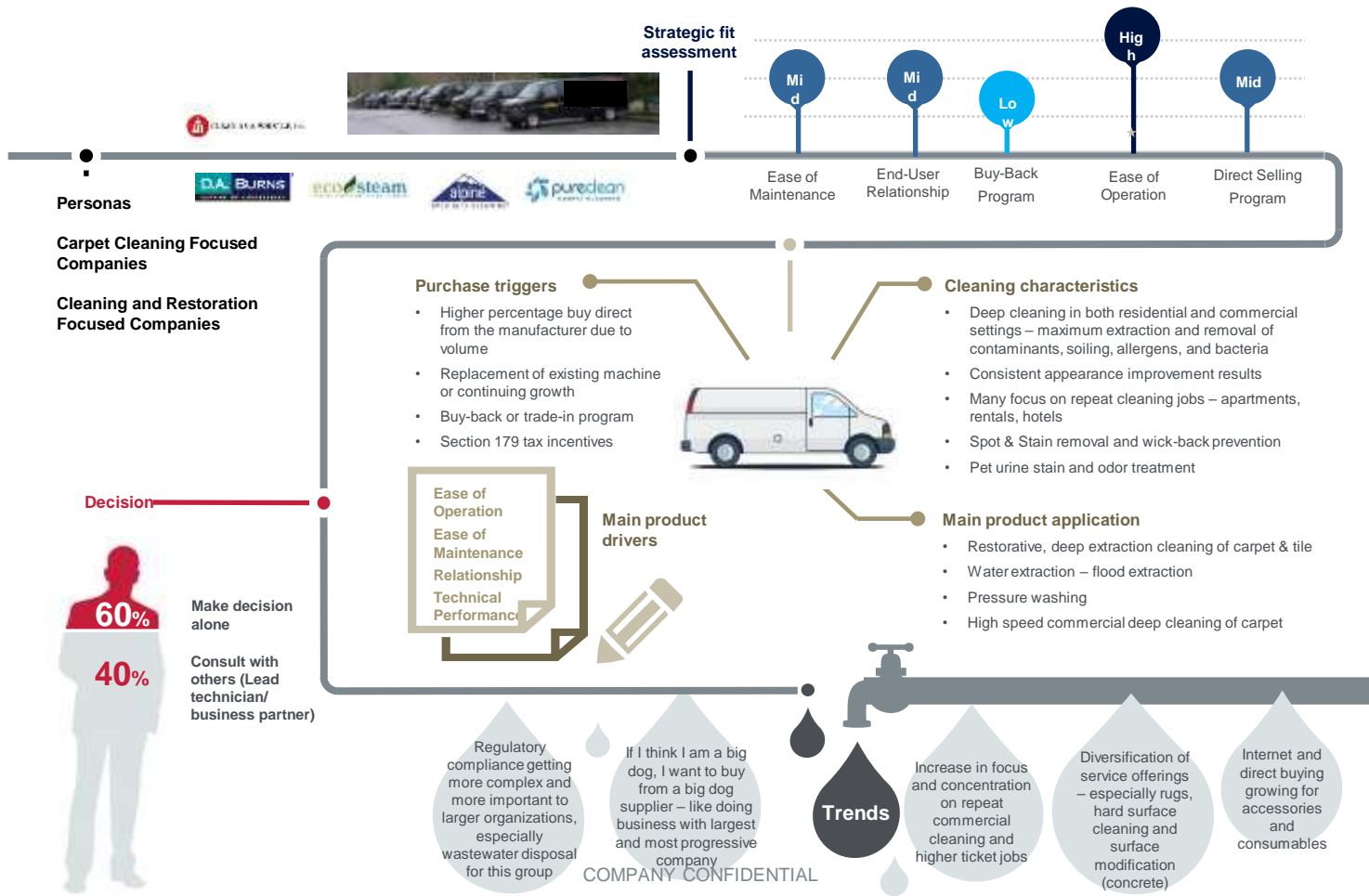

Did we miss somebody?

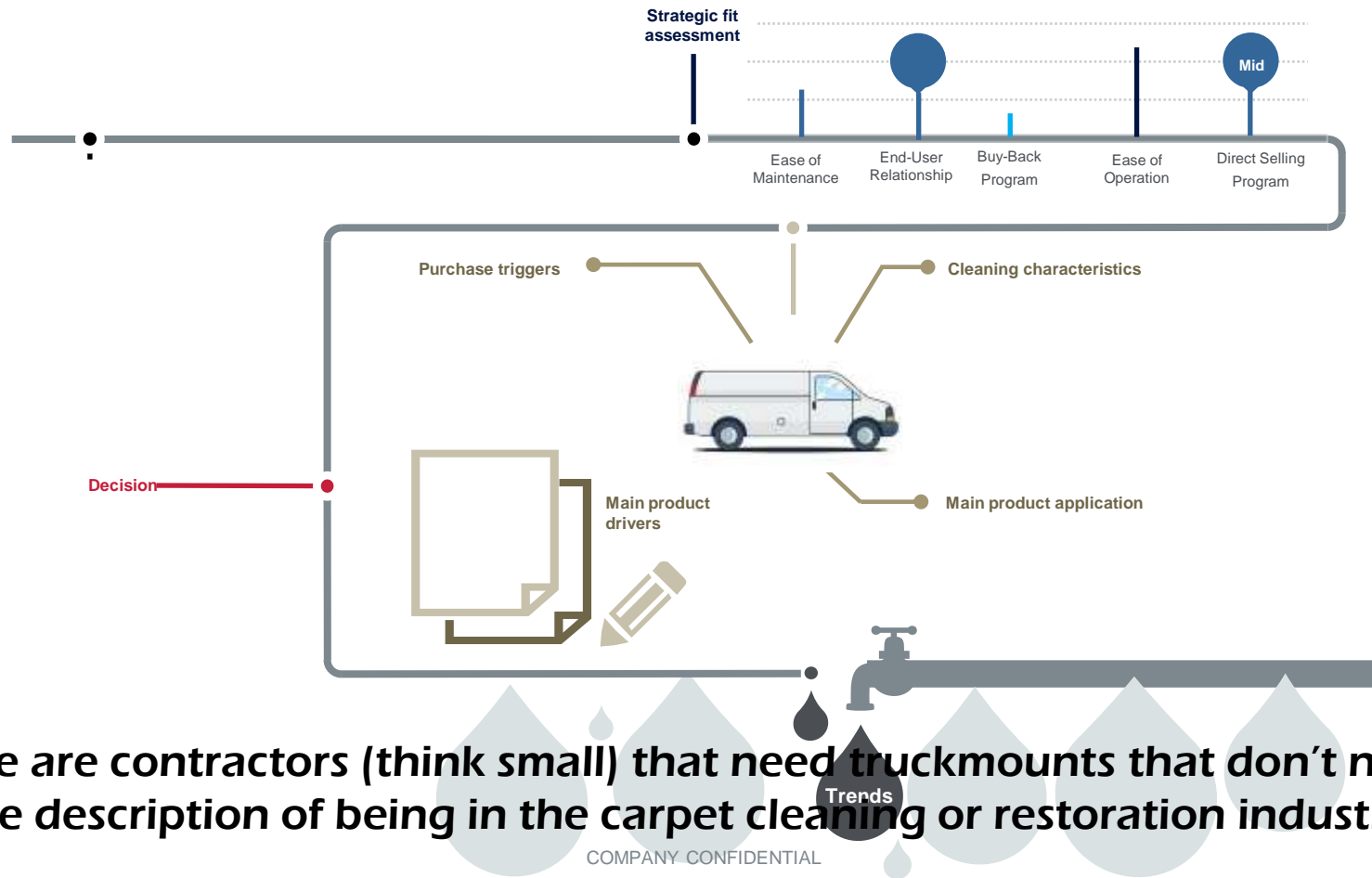

Where else to people who need a truckmount connect up with the industry?

 OfferUp

 craigslist

 ebay



 Google AdWords



 YouTube

- **There are contractors (think small) that need truckmounts that don't necessarily fit the description of being in the carpet cleaning or restoration industry**
- **Some cleaners don't need or want all the bells and whistles. KISS**
- **Distributors are fighting over the 60-70% at the expense of the other 30-40%**
- **They are looking for productivity and fulfilling the requirements of specific jobs**
- **Promote used truckmounts but show how new is a better investment once they have made contact**
- **Use used vans and vehicles as an attractant. That is what they think they can afford.**
- **Does the shoe fit? Start with what kind of payment they can afford – plug that into the machine you have that can match that**
- **\$15,500 - \$18,000 magic point – complete package – machine, hose reel, freshwater tank, installation, hoses, wand**

Showroom and Shop Merchandising



www.hydramaster.com | 800.426.1301 | 425.775.7272

Showroom and Shop Merchandising

**Pound For Pound,
The *BOXSER* Series
Packs a Powerful
Punch**



The *Boxser* Series Truckmounts from HydraMaster lead the way in air-cooled engine, slide-in truck mounts.

MAKES FINE

HydraMaster

The #1 Selling Direct Drive Truckmount in the World!
CDS 4.8



HydraMaster

The #1 Selling Direct Drive Truckmount in the World



**CDS 4.8
OVERDRIVE**

HydraMaster

The Next Generation of Direct Drive Truckmounts



HydraMaster

INVEST IN YOUR UNLIMITED FUTURE. THERE IS NO RESTORATION OR CLEANING JOB TOO CHALLENGING FOR THE TITAN 575.



HydraMaster

**High Performance Portable
Extractors**



King Cobra i200 PEX 500 HydraPort Series Escalator Cleaner

HydraMaster

**RELENTLESS...
TITAN 575**



HydraMaster

TMTQ 4000



HydraMaster

**RELENTLESS...
TITAN 575**



HydraMaster

11 x 17" posters or counter signs – available on request



www.hydramaster.com | 800.426.1301 | 425.775.7272

Showroom and Shop Merchandising

TITAN TOUGH

TITAN 425

TITAN 575

TITAN 325

TITAN TOUGH

HydraMaster
HydraMaster.com

- More intuitive to use panel and directions makes it easier to train new techs and easier to maintain
- Refreshed appearance makes a professional impression to your cleaning and restoration customers
- Machines that match your perseverance in delivering optimum performance

36" x 24" posters

HydraMaster
We've Got Your Back



Made in the USA

www.hydramaster.com | 800.426.1301 | 425.775.7272

Showroom and Shop Merchandising

Authorized Master Distributor



www.HydraMaster.com

HydraMaster
We've Got Your Back



3' x 10' banner

Earned through sales performance or incentives

HydraMaster
We've Got Your Back



Made in the USA

www.hydramaster.com | 800.426.1301 | 425.775.7272

Showroom and Shop Merchandising



Earned through sales performance or incentives

3' x 5' logo mat



www.hydramaster.com | 800.426.1301 | 425.775.7272

Showroom and Shop Merchandising



Showroom display cart

Earned through sales performance or incentives



www.hydramaster.com | 800.426.1301 | 425.775.7272

Product Information Sheets - Truckmounts

Relentless...
Dual-Wind Motor Drive
Features it as the most challenging environment.

Key Features

- Dual-Wind Motor Drive
- 100% Duty Cycle
- 100% Efficiency
- 100% Reliability
- 100% Durability
- 100% Performance
- 100% Satisfaction

TITAN TOUGH

TITAN 575

HydraMaster

www.hydramaster.com | 800.426.1301 | 425.775.7272

A Ferocious Appetite for Clean and Dry
When horsepower, secure feet, better fuel control, less dumping.

Key Features

- 100% Duty Cycle
- 100% Efficiency
- 100% Reliability
- 100% Durability
- 100% Performance
- 100% Satisfaction

TITAN TOUGH

TITAN 425

HydraMaster

www.hydramaster.com | 800.426.1301 | 425.775.7272

Step up your game
Affordable Value... Excellent Performance!

Key Features

- 100% Duty Cycle
- 100% Efficiency
- 100% Reliability
- 100% Durability
- 100% Performance
- 100% Satisfaction

TITAN TOUGH

TITAN 325

HydraMaster

www.hydramaster.com | 800.426.1301 | 425.775.7272

Uncompromising Deep Cleaning and Restorative Extraction

Key Features

- 100% Duty Cycle
- 100% Efficiency
- 100% Reliability
- 100% Durability
- 100% Performance
- 100% Satisfaction

TMTQ 4000™

HydraMaster

www.hydramaster.com | 800.426.1301 | 425.775.7272

TITAN H₂O

Purpose Built for Restoration and Flood Work

Standard Equipment

- 100% Duty Cycle
- 100% Efficiency
- 100% Reliability
- 100% Durability
- 100% Performance
- 100% Satisfaction

HydraMaster

www.hydramaster.com | 800.426.1301 | 425.775.7272

Emboldening Cleaning Business Owners with the Next Most Important Step for Their Success.

It is time for you to add a hard surface dedicated cleaning machine and van to your fleet.

HydraMaster

Boxer 38HP

www.hydramaster.com | 800.426.1301 | 425.775.7272

37HP + 400 CFM + 1200PSI + 245°F + 2 Wandys = The numbers add up to your next hydroevent!

Key Features

- 100% Duty Cycle
- 100% Efficiency
- 100% Reliability
- 100% Durability
- 100% Performance
- 100% Satisfaction

Boxer XL

HydraMaster

www.hydramaster.com | 800.426.1301 | 425.775.7272

The #1 Selling Direct Drive Truckmount in the World!

Key Features

- 100% Duty Cycle
- 100% Efficiency
- 100% Reliability
- 100% Durability
- 100% Performance
- 100% Satisfaction

CDS 4.8™

HydraMaster

www.hydramaster.com | 800.426.1301 | 425.775.7272

The Next Generation of Direct Drive Truckmounts

Key Features

- 100% Duty Cycle
- 100% Efficiency
- 100% Reliability
- 100% Durability
- 100% Performance
- 100% Satisfaction

CDS xDRIVE™

HydraMaster

www.hydramaster.com | 800.426.1301 | 425.775.7272



www.hydramaster.com | 800.426.1301 | 425.775.7272

Product Information Sheets – Portables, Restoration

PEX 500 BACK HOME!

WATER FROM DRAINAGE PANS TO EXTRACTOR



Simple and convenient design
 The PEX 500 is designed for easy installation and use. It features a simple, intuitive control panel and a compact, portable design that fits easily into tight spaces. The unit is built with durable, high-quality materials to ensure long-lasting performance.

Powerful performance, available for daily or weekly maintenance
 The PEX 500 is designed to handle a wide range of water extraction tasks, from routine maintenance to emergency situations. Its powerful motor and advanced filtration system ensure that water is removed quickly and efficiently, leaving your space clean and dry.

Easy to maintain
 The PEX 500 is designed for easy maintenance and repair. It features a simple, intuitive control panel and a compact, portable design that fits easily into tight spaces. The unit is built with durable, high-quality materials to ensure long-lasting performance.

Hygiene through dry dehumidification
 The PEX 500 is designed to provide a clean, dry environment. Its advanced filtration system and dehumidification capabilities help to reduce moisture levels, preventing mold and mildew growth. This makes it an ideal choice for maintaining a healthy and safe indoor environment.

HydraMaster

www.hydramaster.com | 800.426.1301 | 425.775.7272

King Cobra® i200 Pro

MULTI-SURFACE EXTRACTOR



Powerful performance, available for daily or weekly maintenance
 The King Cobra i200 Pro is designed to handle a wide range of water extraction tasks, from routine maintenance to emergency situations. Its powerful motor and advanced filtration system ensure that water is removed quickly and efficiently, leaving your space clean and dry.

Easy to maintain
 The King Cobra i200 Pro is designed for easy maintenance and repair. It features a simple, intuitive control panel and a compact, portable design that fits easily into tight spaces. The unit is built with durable, high-quality materials to ensure long-lasting performance.

Hygiene through dry dehumidification
 The King Cobra i200 Pro is designed to provide a clean, dry environment. Its advanced filtration system and dehumidification capabilities help to reduce moisture levels, preventing mold and mildew growth. This makes it an ideal choice for maintaining a healthy and safe indoor environment.

HydraMaster

www.hydramaster.com | 800.426.1301 | 425.775.7272

Flood King

WATER EXTRACTOR FOR RESTORATION



Powerful performance, available for daily or weekly maintenance
 The Flood King is designed to handle a wide range of water extraction tasks, from routine maintenance to emergency situations. Its powerful motor and advanced filtration system ensure that water is removed quickly and efficiently, leaving your space clean and dry.

Easy to maintain
 The Flood King is designed for easy maintenance and repair. It features a simple, intuitive control panel and a compact, portable design that fits easily into tight spaces. The unit is built with durable, high-quality materials to ensure long-lasting performance.

Hygiene through dry dehumidification
 The Flood King is designed to provide a clean, dry environment. Its advanced filtration system and dehumidification capabilities help to reduce moisture levels, preventing mold and mildew growth. This makes it an ideal choice for maintaining a healthy and safe indoor environment.

HydraMaster

www.hydramaster.com | 800.426.1301 | 425.775.7272

Product Information Sheets – TreadMaster

The TreadMaster™

Automatic Excavator Cleaner



Excavator tracks and housing work with efficiency
 The TreadMaster is designed to clean excavator tracks and housing efficiently. It features a powerful motor and advanced filtration system that ensures thorough cleaning and decontamination of the tracks and housing.

Simple, easy-to-use system
 The TreadMaster is designed for easy installation and use. It features a simple, intuitive control panel and a compact, portable design that fits easily into tight spaces. The unit is built with durable, high-quality materials to ensure long-lasting performance.

TreadMaster is efficient
 The TreadMaster is designed to provide a clean, dry environment. Its advanced filtration system and dehumidification capabilities help to reduce moisture levels, preventing mold and mildew growth. This makes it an ideal choice for maintaining a healthy and safe indoor environment.

TreadMaster is safe
 The TreadMaster is designed to provide a clean, dry environment. Its advanced filtration system and dehumidification capabilities help to reduce moisture levels, preventing mold and mildew growth. This makes it an ideal choice for maintaining a healthy and safe indoor environment.

A Design that's easy to use
 The TreadMaster is designed for easy installation and use. It features a simple, intuitive control panel and a compact, portable design that fits easily into tight spaces. The unit is built with durable, high-quality materials to ensure long-lasting performance.

Excavator Tread Clean System

HydraMaster

www.hydramaster.com | 800.426.1301 | 425.775.7272



www.hydramaster.com | 800.426.1301 | 425.775.7272

Product Information Sheets – Tools & Accessories

EVOLUTION Wand & Tool Series

Manufactured with Duro® Gables
 Best-in-class | 100% Heavy-Duty | 100% Durable

Best-in-class Wand & Tool Series

100% Heavy-Duty | 100% Durable

HydraMaster
 1-800-426-1301 | www.hydramaster.com

EVOLUTION Wand & Tool Series

Manufactured with Duro® Gables
 Best-in-class | 100% Heavy-Duty | 100% Durable

Best-in-class Wand & Tool Series

100% Heavy-Duty | 100% Durable

HydraMaster
 1-800-426-1301 | www.hydramaster.com

OrMaster 3 Upholstery Cleaning Tool

100% Heavy-Duty | 100% Durable

HydraMaster
 1-800-426-1301 | www.hydramaster.com

R-20 Rotary Jet Extractor

The Most Powerful Rotary Jet Extractor

HydraMaster
 1-800-426-1301 | www.hydramaster.com

EVOLUTION R-12

100% Heavy-Duty | 100% Durable

HydraMaster
 1-800-426-1301 | www.hydramaster.com

EVOLUTION Glided Upholstery Tool

100% Heavy-Duty | 100% Durable

HydraMaster
 1-800-426-1301 | www.hydramaster.com

EVOLUTION Stair Wand

100% Heavy-Duty | 100% Durable

HydraMaster
 1-800-426-1301 | www.hydramaster.com

EVOLUTION WAND RACK HOLDER

100% Heavy-Duty | 100% Durable

HydraMaster
 1-800-426-1301 | www.hydramaster.com



www.hydramaster.com | 800.426.1301 | 425.775.7272

CDS xDRIVE
XCELERATED DRIVE SYSTEM

ISSA
INNOVATION
AWARD



Demo Trucks at Events?

HydraMaster
We've Got Your Back



Made in the USA

www.hydramaster.com | 800.426.1301 | 425.775.7272



Demo Trucks at Events?

HydraMaster
We've Got Your Back



Made in the USA

www.hydramaster.com | 800.426.1301 | 425.775.7272

What's new at
HydraMaster 3.0

[CLICK HERE](#)



EVOLUTION
STAIR WAND

EVOLUTION
RX12

RX20 NEXT GEN



TMTG TRUCKMOUNT
TO GO



TITAN SERIES



EVOLUTION
UPHOLSTERY
TOOL

PEX 500

HydraMaster
We've Got Your Back



Made in the USA

www.hydramaster.com | 800.426.1301 | 425.775.7272



HydraMaster Truckmount Troubleshooting App

This app will help you troubleshoot some common questions while operating and maintaining your HydraMaster equipment.



- On the job immediate support 24/7/365
- HydraMaster Distributor Locator
- Great for training technicians
- Access diagrams, charts, videos and more!
- Quick link to HydraMaster Tech Support
- GM/Ford Service Dealer Locator



Get the APP!



www.hydramaster.com | 800.426.1301 | 425.775.7272

How the TMTG4000 Truckmount to Go Can Open Up New Doors for Truckmount Sales



www.hydramaster.com | 800.426.1301 | 425.775.7272

TMTG 4000™

NEW!



- Corporate Campuses
- Resorts
- Restoration Companies
- Amusement Parks
- College Campuses
- Airports
- Studios
- Anywhere you have a cluster of buildings without roadside access to them
- Parking closer to the building – when you don't want hoses being strewn across areas where people walk

HydraMaster
We've Got Your Back



Made in the USA

www.hydramaster.com | 800.426.1301 | 425.775.7272

TRUCKMOUNT TO GO™ MOBILE CLEANING & RESTORATION PLANT

TMTG 4000™



Made in the USA

www.hydramaster.com | 800.426.1301 | 425.775.7272

TMTG 4000™



What is a Truckmount to Go?

The HydraMaster TMTG4000 Truck Mount to Go is a mobile, high performance cleaning and extraction system designed for restoration and cleaning contractors, facility managers, and disaster emergency response teams who need an easy to operate and easy to transport unit. It can be directly delivered to the job site and off-loaded for immediate and on-going deep cleaning and extraction of carpets, upholstery, hard surface floors, sidewalk, porches and entry way cleaning; water and flood extraction, and pressure washing where immediate collection of cleaning solutions and soiling are beneficial.

HydraMaster
We've Got Your Back



Made in the USA

www.hydramaster.com | 800.426.1301 | 425.775.7272

TMTG 4000™

How does it work?

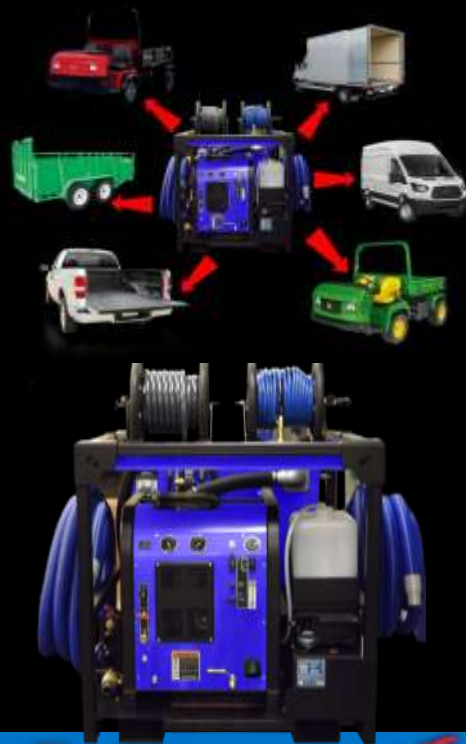

The complete self-contained, turn-key system can be transported via flatbed or pick-up truck, van, trailer, container, pod, or even an industrial cart. As the unit provides its own power, no electricity is needed. The complete system includes: a wastewater recovery tank; high capacity automatic wastewater disposal system (for pumping wastewater to an on-location sanitary sewage access point); fuel tank; solution hoses mounted on a high capacity hose reel; vacuum hoses mounted on a hook, and a cleaning and extraction wand. In addition, the TMTG uses a state-of-the-art heat exchange system to heat the cleaning solution which, eliminates the need for the second fuel source required by hot water pressure washers.

HydraMaster
We've Got Your Back



Made in the USA

www.hydramaster.com | 800.426.1301 | 425.775.7272

TMTG 4000™



Permanent Vehicle Mounting is Not Required

The TMTG does not require the contractor or facility to permanently tie up the transport vehicle. The unit is simply forklifted into the transport vehicle for delivery to the job site, or shipped by container or crate to the worksite.

Applications

- Carpet Cleaning
- Water and flood extraction
- Upholstery Cleaning
- Stone, Tile & Concrete Floor Cleaning
- Hard Surface Floors
- Water Damage Restoration
- Pressure Washing
- Vehicle Detailing

HydraMaster
We've Got Your Back



Made in the USA

www.hydramaster.com | 800.426.1301 | 425.775.7272

TMTG 4000™



- ✓ TMTG is not just limited to water extraction like other mobile systems. It provides restorative, deep cleaning and water extraction capabilities. Most restoration job sites require comprehensive deep cleaning needs after the flood waters have been extracted
- ✓ Proven power, vacuum, and cleaning solution delivery platform used on HydraMaster's most popular slide-in mounted truckmount systems
- ✓ Protective sub-frame equipped with forklift guides for safe and easy loading and unloading
- ✓ Lightweight enough it can be loaded on John Deere ProGator® or Toro Workman® utility vehicles for easy transport on college and industrial campuses, amusement parks, and resorts.

HydraMaster
We've Got Your Back



Made in the USA

www.hydramaster.com | 800.426.1301 | 425.775.7272

TMTG 4000™

Specifications

- **Power Plant:** 23HP Briggs & Stratton Vanguard Air Cooled gasoline engine operating at 3000 RPM (Approximately 1.1 gph of fuel consumption)
- **Vacuum Blower:** Tuthill Dominator 4005 positive displacement blower. Directly coupled for Vacuum to 12"Hg and up to 350+ CFM
- **Solution Pump:** Comet 3.5 gpm solution pump with up to 1000 operating psi
- **Heating System:** Dual stage Thermal Capture and Heat Exchange System for cleaning solution temperatures consistently maintained above 200°F at 1.5gpm water flow
- **Frame:** Corrosion-resistant powder coated steel
- **Automatic Wastewater Disposal System**
- **Fuel tank and supply system** will be EPA/CARB certified for permeation and evaporative emissions compliance and is NFPA approved for safety



TRUCKMOUNT TO GO™ MOBILE CLEANING & RESTORATION PLANT

TMTG 4000™



HydraMaster
We've Got Your Back



Made in the USA

www.hydramaster.com | 800.426.1301 | 425.775.7272

The New TITAN Series of Slide-in Truckmounts



www.hydramaster.com | 800.426.1301 | 425.775.7272



HydraMaster
We've Got Your Back



Made in the USA

www.hydramaster.com | 800.426.1301 | 425.775.7272



HydraMaster
We've Got Your Back



Made in the USA

www.hydramaster.com | 800.426.1301 | 425.775.7272



HydraMaster
We've Got Your Back



Made in the USA

www.hydramaster.com | 800.426.1301 | 425.775.7272

TITAN TOUGH



HydraMaster
We've Got Your Back



Made in the USA

www.hydramaster.com | 800.426.1301 | 425.775.7272

TITAN TOUGH

**“Tough as Nails” TITAN quality
with a sleek new design**



www.hydramaster.com | 800.426.1301 | 425.775.7272

TITAN TOUGH

**More intuitive and easier to use
panel directions and graphics make
it easier to train new technicians
and easier to maintain**



www.hydramaster.com | 800.426.1301 | 425.775.7272

TITAN TOUGH

Enhanced appearance makes an impression on your professionalism to your cleaning or restoration customer



www.hydramaster.com | 800.426.1301 | 425.775.7272

TITAN TOUGH

**Truckmounts that match your
perseverance at delivering
optimum performance to your
customers**



www.hydramaster.com | 800.426.1301 | 425.775.7272

TITAN TOUGH

**Legendary performance and
reliability from the innovation
leader since 1971**



www.hydramaster.com | 800.426.1301 | 425.775.7272

Relentless



Dual wand workhorse

TITAN 575

HydraMaster
We've Got Your Back



Made in the USA

www.hydramaster.com | 800.426.1301 | 425.775.7272

Relentless



TITAN 575

Performance in the most challenging environments



Made in the USA

www.hydramaster.com | 800.426.1301 | 425.775.7272

Key Features

- ✓ **Liquid Cooled Kubota 32.5HP Engine** - Delivers Maximum Power and Reliable Longevity.
- ✓ **Uncompromising Cleaning Solution Temperature** - Best in class performance — single wand, dual wand, or hard surface cleaning. Unwavering heat from 230°-250° F.
- ✓ **Vacuum and Water Extraction Recovery** - 400+ CFM for Faster Drying, Faster Restoration!
- ✓ **Dual Wand Capable** - plumbed and prepared for you to double your productivity when you need to!
- ✓ **Patented Heat Control System**, ADC Control Diverter manages heat for more consistent temperature delivery and virtually eliminates dumping fresh water during cleaning and water extraction.
- ✓ **Quieter Performance** - Opti Air Flow System and dual oil bath helical gear tri-lobe blower reduces noise resulting in the quietest machine in its class.
- ✓ **Simplified Maintenance** - "Arms Length" design and removable magnetic panels allow for easy access to crucial components and serviceable parts.



TITAN 575 HydraMaster
We've Got Your Back



Made in the USA

www.hydramaster.com | 800.426.1301 | 425.775.7272

When it comes to cleaning solution temperature, there are a lot of empty promises made with truckmounts. The **TITAN 575** from HydraMaster deliver uncompromising, unwavering hot cleaning solution temperature even under the most demanding conditions.



TITAN 575



HydraMaster
We've Got Your Back

Invest in your unlimited future



Made in the USA

www.hydramaster.com | 800.426.1301 | 425.775.7272

When it comes to cleaning solution temperature, there are a lot of empty promises made with truckmounts. The **TITAN 575** from HydraMaster deliver uncompromising, unwavering hot cleaning solution temperature even under the most demanding conditions.



TITAN 575



HydraMaster
We've Got Your Back

Invest in your unlimited future



Made in the USA

www.hydramaster.com | 800.426.1301 | 425.775.7272



In fact, field testing clearly demonstrates that the **TITAN 575** consistently produced 20-30°F degree higher temperatures under carpet and hard surface cleaning solution flow demand than comparable leading brand heat exchange truckmounts. If you want the hottest truckmount, the **TITAN 575** is for you.

TITAN 575



Invest in your unlimited future



Made in the USA

www.hydramaster.com | 800.426.1301 | 425.775.7272

The **TITAN 575** is a **TITAN** amongst truckmounts, allowing you to run two wands so you can take on those big cleaning jobs with confidence and get the job done twice as fast. Incorporating HydraMaster's industry exclusive true water conservation system, it can be inactive under a full vacuum load for as long as 40 minutes without wasting fresh water.



TITAN 575



HydraMaster
We've Got Your Back

Invest in your unlimited future



Made in the USA

www.hydramaster.com | 800.426.1301 | 425.775.7272



That means you can move furniture or apply prespray without running to shut off your machine, and your fresh water and recovery tanks need to be filled and emptied less often. Your hot water is used on the job, not dumped into the recovery tank, saving precious fuel each and every day. The **TITAN 575** was designed for reliability and serviceability; removable magnetic panels make maintenance a cinch. For EXTREME performance in a compact and reliable package, the **TITAN 575** has got your back.

TITAN 575



Invest in your unlimited future



Made in the USA

www.hydramaster.com | 800.426.1301 | 425.775.7272

"I purchased a TITAN 575 about 2 months ago. I wish I had known about the capabilities of the 575 a long time ago. This machine is amazing! With my Prochem® Peak® I would spend 20 minutes warming it up. Not anymore! The heat on the TITAN 575 is incredible. I have drying times as little as 1 hour and I can clean all day on my 100 gallon tank. I just had to let you know because there are a lot of carpet cleaners that don't know just how advanced HydraMaster truckmounts have become. Thank you!"

John Rogers



TITAN
575 **HydraMaster**
We've Got Your Back

Invest in your unlimited future



Made in the USA

www.hydramaster.com | 800.426.1301 | 425.775.7272

Specifications:

Engine: Kubota 32.5HP Liquid Cooled Engine

- Fuel efficient – 1.7 gph at 300psi
- Keyless electronic ignition
- Exceptionally rigid cast iron block
- 3 cylinder OHV design

Solution Pump: Plunger pump with 2000 operating psi

- General HTX-1813 4.0 gpm solution pump
- 1200 psi heated pressure

Vacuum: 4007 Dominator Tri-Lobe Blower, 400+ CFM

- Direct coupler driven
- HydraMaster exclusive design
- Dual oil bath design with sight level windows
- Durable helical gear drive

Heating System: Full Divert Tube and finned tube Heat Exchanger

- Automatic Diverter Control (ADC) temperature control
- Attains 265°F temperature (200-210°F continuous flow at 1.25GPM)
- Patented design and function: U.S. Patent No. 8,032,976

Dimensions: - 39"H x 26"W x 45"D

Wand Capability: Dual wand, full performance

Weight: 900lbs (console weight)

Chemical System:

- Last-step chemical injection,
- Meter controlled

Applications:

- Residential, Large Commercial Carpet Cleaning
- Pressure Washing with full waste recovery capabilities
- Upholstery Cleaning
- Stone, Tile and Grout Cleaning
- Hard surface high pressure cleaning



Invest in your unlimited future

TITAN 425

HydraMaster
We've Got Your Back



Made in the USA

www.hydramaster.com | 800.426.1301 | 425.775.7272

A ferocious appetite for clean & dry

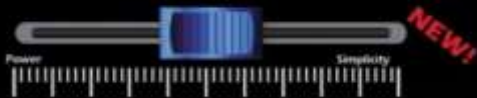

The perfect balance of power and simplicity

TITAN 425



Made in the USA

www.hydramaster.com | 800.426.1301 | 425.775.7272

A ferocious appetite for clean & dry

Key Features

- ✓ **More Power**
23 HP Air Cooled Engine - Briggs & Stratton® Vanguard™ Air Cooled Engine.
- ✓ **Quieter Performance**
Opti-Air® Flow System - Reduces noise resulting in the quietest machine in its class.
- ✓ **Patented Heat Control System** - ADC Control Diverter valve manages heat for more consistent temperature delivery and far less water dumping.
- ✓ **Compact Footprint** - Maximizes the van space more efficiently creating greater cubic feet for your gear.
- ✓ **Simpler Maintenance** - "Arms-length" design and removable panels allow easy access to crucial components and serviceable parts, including the heat exchanger.
- ✓ **Stronger Vacuum** - Helical gear splash lube tri-lobe blower produces 350+ CFM resulting in faster drying carpet and floors.



More horsepower, more heat

TITAN 425



Made in the USA

www.hydramaster.com | 800.426.1301 | 425.775.7272

TITAN 425 vs The Competition

- It has all the power and performance you need without overkill. The 23HP Briggs & Stratton Vanguard Engine provides you with more horsepower than most machines in its class – 12% more power which will allow your machine to operate better at elevated conditions and under maximum load conditions. This also extends the life of the engine.
- Control is a key also – the TITAN 425 allows you to choose the exact cleaning solution temperature you want rather than just a pre-determined setting.
- Simplicity reigns supreme, starting with the fact that the proven coupling system open configuration allows for excellent air circulation, while the competition's belt driven system requires a belt cooling fan, adding one more layer of complexity.



Better heat control, less dumping

TITAN 425



www.hydramaster.com | 800.426.1301 | 425.775.7272

TITAN 425 vs The Competition



- The TITAN 425 is equipped with a water box drain valve which makes the machine easier to freeze guard, descale and service. With the competition's machine the water box has to be drained by running the machine.
- Plus because the TITAN 425 is 150# lighter than the competition, you will get improved gas mileage from your van and less wear on vehicle components.
- The TITAN 425 is easier to maintain too. It is designed around the HydraMaster "Arms-Length" philosophy of accessibility.



TITAN 425

HydraMaster
We've Got Your Back



Made in the USA

www.hydramaster.com | 800.426.1301 | 425.775.7272

TITAN 425 vs The Competition

- The TITAN 425 blower drive system can be easily serviced in less than an hour with easily accessibility to the drive system. Blower oil drain hoses make changing your blower oil easier to do, and with less mess. The competition uses plugs that are hard to get to. Magnetic panels allow for quick and easy access to all components.
- The patented heat control system with the ADC Control Diverter manages heat for more consistent temperature delivery and far less water dumping. In fact, in comparison testing, the TITAN 425 maintains a 5 -10° Fahrenheit temperature advantage versus the competition in a continuous flow mode for hard surface cleaning and pressure washing.
- The OptiAir Flow System reduces noise resulting in a quieter machine. The compact footprint maximizes the van space creating greater cubic feet for your gear and without being too “top-heavy” like some machines.
- Finally , the helical gear splash lube tri-lobe blower produces 350+ CFM resulting in faster drying carpets and floors and better water extraction.



TITAN 425



HydraMaster
We've Got Your Back



Made in the USA

www.hydramaster.com | 800.426.1301 | 425.775.7272

Easier, Quieter, and Ready for Your Greatest Cleaning Challenge

- The TITAN 425 has also reduced noise by optimizing airflow with the OPTI-AIR™ flow system through the entire machine which provides more consistent heat performance and makes the machine quieter in operation. You can clean everything from the filthiest carpet, to the most delicate upholstery fabric, to the grimeiest tile or concrete floor.
- The TITAN 425 heat control system automatically manages water heating – allowing less water dumping, and gives more consistent temperatures during intermittent wand use; e.g., moving furniture while cleaning. With heated solution of 1000psi, you are ready for just about any cleaning job. It's excellent for flood extraction too.



TITAN 425

HydraMaster
We've Got Your Back



Made in the USA

www.hydramaster.com | 800.426.1301 | 425.775.7272

Briggs and Stratton Vanguard Engine

- 23 HP Engine
- Dependable 2 Cylinder OHV Design
- Fuel-Efficient Technology
- External Oil Cooler
- Keyed ignition
- Engine choke and throttle
- 1.1 gph fuel consumption

MD Pneumatics Competitor 4005 Tri-Lobe Blower

- HydraMaster Exclusive Design
- Pulsation and Sound Reduced
- No Grease Fittings, Oil bath at both ends
- Helical Gear Drive
- Oil Level Sight Windows



Multi-Stage Heat Exchangers

- Advanced Heat-Exchanger System
- 240° Maximum Temperature, 160° to 235° Operating Range
- Stainless steel coil Engine Exhaust Exchanger
- Divert tube and fin Blower Exhaust Exchanger

Comet Pressure Pump

- 3.5 gpm plunger solution pump
- Operating Pressure, 0 to 1,000 PSI
- Electric Clutch

Dimensions: - 24"W x 32"H x 36"D

Wand Capability: Single

Weight: 563 lbs. (Console weight)

TITAN 425

Chemical System: Last-step chemical injection, meter controlled

Applications:

- Residential, Commercial Carpet Cleaning
- Pressure Washing with full waste recovery capabilities
- Upholstery Cleaning
- Concrete, stone, Tile and Grout Cleaning
- Hard surface high pressure cleaning
- Water extraction



HydraMaster
We've Got Your Back



Made in the USA

www.hydramaster.com | 800.426.1301 | 425.775.7272

Step up your game



**Affordable Value . . .
Radical Performance!**

TITAN 325



HydraMaster
We've Got Your Back



Made in the USA

www.hydramaster.com | 800.426.1301 | 425.775.7272

Step up your game

Perfectly sized for companies who do residential and light commercial who also do water damage restoration! Finally, you don't have to put up with barely adequate performance to get an affordable entry-level machine. The **TITAN 325** takes the entry level truckmount to new heights. It's perfect for operators who want to **step up their game.**



**Affordable Value . . .
Radical Performance!**

TITAN 325



HydraMaster
We've Got Your Back



Made in the USA

www.hydramaster.com | 800.426.1301 | 425.775.7272

Step up your game

Plus the new TITAN 325 is equipped with an expanded fin tubed heat exchange thermal accumulation system with **40% more heating capacity** than before. The TITAN 325 has been tested to be the **HOTTEST machine in its class**



**Affordable Value . . .
Radical Performance!**

TITAN 325

HydraMaster
We've Got Your Back



Made in the USA

www.hydramaster.com | 800.426.1301 | 425.775.7272

Affordable Value . . . Radical Performance!

Key Features

- ✓ **Reliable, Fuel Efficient Power** – Briggs & Stratton Vanguard 18HP gas/petrol engine.
- ✓ **Space** – saving footprint for more cargo space to carry all of year other gear
- ✓ **Simple to operate and maintain** – Intuitive, easy to use panel directions and graphics make it easier to train new technicians and easier to maintain
- ✓ **40% more heating capacity** – expanded fin tubed heat exchange/thermal accumulation system produces the hottest cleaning solution of any machine in its class.
- ✓ **Powerful recovery** – Tuthill Competitor 3006 Vacuum Blower produces consistent, reliable vacuum with hardened precision helical gears
- ✓ **Hydra-Clutch equipped, Perfect for water extraction and water damage restoration** – The new HydraClutch™ pump clutch allows the solution pressure side of the machine to be turned off while performing flood and water extraction with your truckmount which reduces wear and protects components



TITAN 325



HydraMaster
We've Got Your Back



Made in the USA

www.hydramaster.com | 800.426.1301 | 425.775.7272

The HydraClutch™ pump clutch allows the solution pressure side of the machine to be turned off while performing flood and water extraction with your truckmount which reduces wear and protects components. The primary advantage is the machine does not require a water source to be connected to the machine to keep operating. With the pump turned off the machine will not add water to the recovery tank, as it no longer is required to pump high pressure water to maintain internal temperatures. This allows for an increased capacity in the recovery tank, maximizing your time in extracting water. This also enables the machine to be operated in any location as it is not necessary to be near a fresh water source.



TITAN 325

HydraMaster
We've Got Your Back



Made in the USA

www.hydramaster.com | 800.426.1301 | 425.775.7272

Best of all, you'll be investing in a truckmount with the reliability and proven track record that only comes with owning a HydraMaster.

Key Features:

- Space saving design – takes up less cubic feet in the van or trailer
- Compact, tested design – easy for new operators to learn how to achieve excellent results
- Hydra-Clutch Pump Clutch Standard
- Hard surface cleaning at 1,000 psi
- Easy Maintenance, high reliability
- Quieter operation



TITAN 325

HydraMaster
We've Got Your Back



Made in the USA

www.hydramaster.com | 800.426.1301 | 425.775.7272

Machine Specifications:

Briggs & Stratton®

Vanguard™ Engine:

- Fuel-efficient 18 HP engine
- Reliable 2 cylinder OHV design
- Keyed ignition
- Easy maintenance

Competitor® SL 3006 Blower

- Hardened, precision helical gears
- Double row ball bearings at gear end
- Precision machined ductile iron rotors
- Dual oil bath design with oil level sight windows

Comet High Pressure Pump:

- 3.5 gpm capacity
- Operating pressure, 0 to 1,000 psi
- Clean carpet and hard surfaces

- ❑ Dimensions: 24"W x 31"H x 36"D
- ❑ Weight: 570 lbs
- ❑ Ignition: Electric key start
- ❑ Hydra-Clutch Pump Clutch
- ❑ Chemical System: last-step chemical injection, meter controlled
- ❑ Heating System: **Expanded Finned tube heat exchanger /thermal accumulator** with copper tubes for max temperature up to 220°F (170-200°F at 1.25gpm water flow)
- ❑ Wand Capacity: Single
- ❑ Fuel Consumption: 1.0 gph
- ❑ Uses: Residential and Light Commercial



**Affordable Value .
Radical Performance!**

TITAN 325

HydraMaster
We've Got Your Back



Made in the USA

www.hydramaster.com | 800.426.1301 | 425.775.7272

The CDS xDRIVE and the future of direct drive technology



www.hydramaster.com | 800.426.1301 | 425.775.7272

The Next Generation of Direct Drive Truckmounts

CDS xDRIVE
ACCELERATED DRIVE SYSTEM



NEW!



HydraMaster
We've Got Your Back



Made in the USA

www.hydramaster.com | 800.426.1301 | 425.775.7272

The Next Generation of Direct Drive Truckmounts

CDS xDRIVE
XCELERATED DRIVE SYSTEM

- **INSTALLED IN A FORD TRANSIT** – the ideal state-of-the-art work vehicle for the cleaning and restoration professional
- **XDRIVE XCELERATED DRIVE SYSTEM** – providing the most precise, consistent power delivery control of any truckmount made for better cleaning performance
- **PATENT PENDING DESIGN AND ENGINEERING** – True innovation in an electric energy delivery system for a Direct Drive Truckmount
- **SOFT START-SOFT SHUTDOWN SYSTEM** – Smoother operation and less stress on all major components
- **ARM'S LENGTH ACCESS AND SERVICEABILITY, CONSTRUCTED FOR EASE OF INSTALLATION** - No more tensioning v-belts and lining up drive shafts and couplers
- **BOOST SETTING** for those especially challenging cleaning jobs



HydraMaster
We've Got Your Back



Made in the USA

www.hydramaster.com | 800.426.1301 | 425.775.7272

CDS xDRIVE

XCELERATED DRIVE SYSTEM

Controller

Motor

Generator



Made in the USA

www.hydramaster.com | 800.426.1301 | 425.775.7272

HydraMaster
We've Got Your Back

The Next Generation of Direct Drive Truckmounts

CDS xDRIVE
ACCELERATED DRIVE SYSTEM

How Does The CDSX DRIVE Power Delivery System Work?

- The CDS XDrive will revolutionize direct drive and pto truckmounts in the cleaning and restoration industry with computer programmed operational precision.
- The CDS XDRIVE uses the power and heating source already provided by the host vehicle engine.

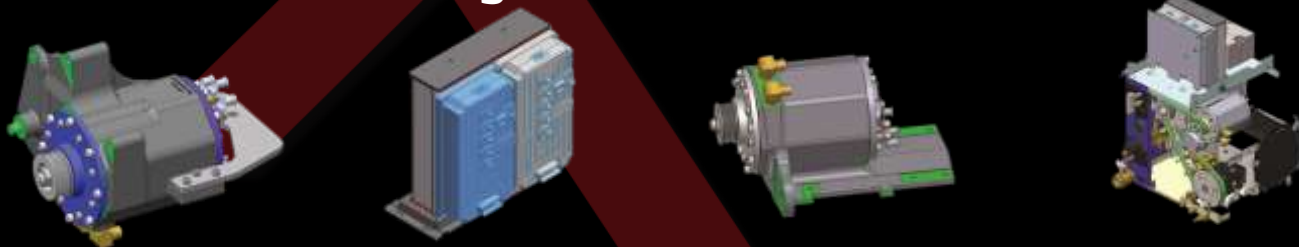

HydraMaster
We've Got Your Back



Made in the USA

www.hydramaster.com | 800.426.1301 | 425.775.7272

The Next Generation of Direct Drive Truckmounts

CDS xDRIVE
XCELERATED DRIVE SYSTEM

How Does The CDS xDRIVE Power Delivery System Work?

- The concept behind the revolutionary, game changing technology of the **CDS xDRIVE** lies in the **XCELERATED** Drive System. The **XCELERATED** Drive System is state-of-the-art technology that uses a specially designed and engine mounted generator to transfer energy to a computerized power monitoring controller. **This collected energy is delivered at precise pre-programmed consistent levels** to an electric motor. The electric motor powers a shaft and belt system delivering consistent **direct non-fluctuating energy to the vacuum blower and solution pump.**
- This patent pending design provides the **most consistent power delivery control to the vacuum blower and other major components of ANY truckmount** – slide-in or direct - **providing your customers with faster drying times and more consistent cleaning!**

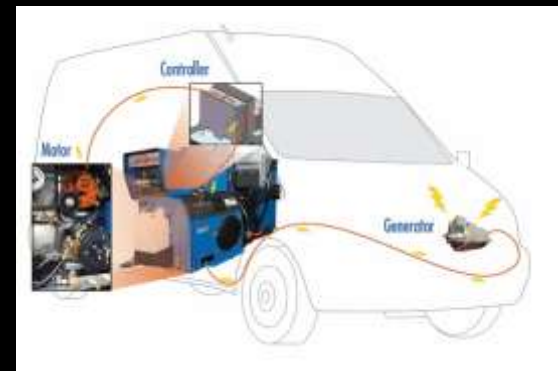

HydraMaster
We've Got Your Back



Made in the USA

www.hydramaster.com | 800.426.1301 | 425.775.7272

The Next Generation of Direct Drive Truckmounts



How Does The CDS xDRIVE Power Delivery System Work?

- This computerized system provides a higher level of consistent energy transfer than a drive shaft or power take off system, reducing the fluctuations in vacuum blower airflow production for a more consistent drying performance.
- Essentially, a drive shaft or power take off system has been replaced with precise, computerized electric energy delivering system. The wear and tear on the engine of the van is reduced.
- Power is no longer measured in RPM's and Horsepower. These measurements have been replaced with wattage generation. The CDS xDRIVE produces a maximum power flow of 18 Kw.



www.hydramaster.com | 800.426.1301 | 425.775.7272

The Next Generation of Direct Drive Truckmounts

CDS xDRIVE
ACCELERATED DRIVE SYSTEM

Mechanical Stress

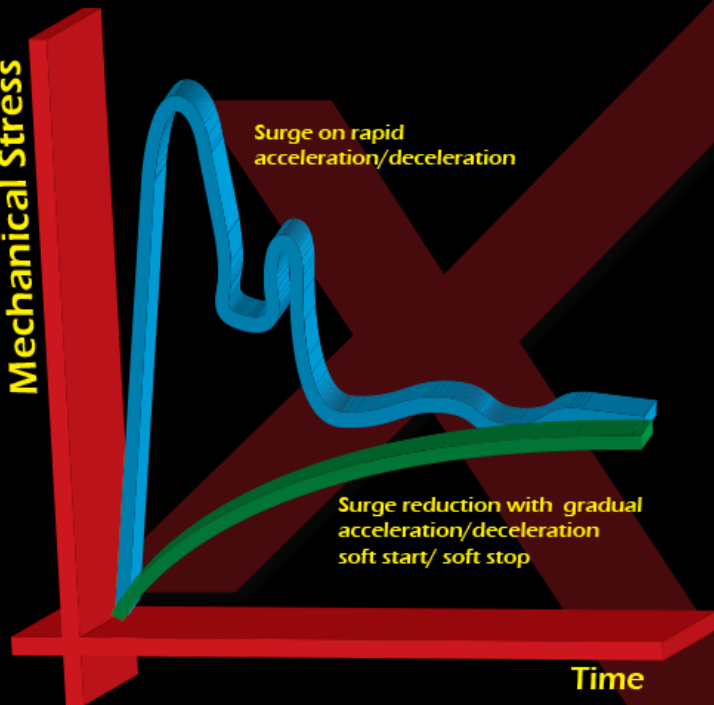

Soft Start – Soft Shutdown System for smoother operation

- This computerized power system provides a soft start to ramp up rpm's to the vacuum blower and a soft shutdown to ramp down rpm's. This smoother delivery extends the life of the vacuum blower and puts less stress on all major components



HydraMaster
We've Got Your Back



Made in the USA

www.hydramaster.com | 800.426.1301 | 425.775.7272

The Next Generation of Direct Drive Truckmounts

CDS xDRIVE
ACCELERATED DRIVE SYSTEM

Provides you with a BOOST setting for those especially challenging cleaning jobs

- The proprietary **BOOST setting** is the first of its kind for a direct-drive truckmount. It allows your truckmount to **maximize blower speed to optimize system performance**. If you need more vacuum cfm, more vacuum lift, and maximum cleaning solution temperature, the BOOST setting is ready for you!
- The **precision controller automatically safeguards against overheating and maintains reliable operating conditions under extreme conditions**. You don't have to worry about anything other than cleaning those trashed carpets or hard surface floors or extracting those big floods.



HydraMaster
We've Got Your Back



Made in the USA

www.hydramaster.com | 800.426.1301 | 425.775.7272

The Next Generation of Direct Drive Truckmounts

CDS xDRIVE ACCELERATED DRIVE SYSTEM

Constructed for ease of installation

- All components, including heat exchanger and noise suppression silencer, are built into the drop in console connected to waste tank, maximizing cargo space
- Front end power generation unit mounts on existing alternator mount and requires no permanent modification to vehicle



HydraMaster
We've Got Your Back



Made in the USA

www.hydramaster.com | 800.426.1301 | 425.775.7272

The Next Generation of Direct Drive Truckmounts

CDS xDRIVE
ACCELERATED DRIVE SYSTEM

"Arms - Length" Access and Serviceability

- Automatic belt tensioner allows easy belt changes and alignment
- Improved access to blower, solution pump, and filters
- Eliminated drive shaft and pillow blocks (as compared to conventional direct drive units) reduces need for associated lubrication and maintenance

Gone are the days of tensioning v-belts, lining up drive shafts, replacing couplers. With the xDrive system maintenance is reduced to nothing more than regular oil changes.



HydraMaster
We've Got Your Back



Made in the USA

www.hydramaster.com | 800.426.1301 | 425.775.7272

The Next Generation of Direct Drive Truckmounts



How Does the CDS XDrive Heating System Work

The CDS XDRIVE employs a multi-stage thermal accumulation and heat exchanger system to create a consistent hot cleaning solution temperature that maximizes at 235 degrees Fahrenheit and can consistently maintain 180-210 degree temperatures at a constant solution flow of 1.25 gpm. The first heat exchanger system employs a fin tube heat exchanger that transfers the hot solution generated by the host vehicle engine. The second stage of the system captures the direct heat being generated by the vacuum blower.



www.hydramaster.com | 800.426.1301 | 425.775.7272

The Next Generation of Direct Drive Truckmounts

CDS xDRIVE
ACCELERATED DRIVE SYSTEM

Durable TriFlow Gardner Denver 4008 Tri-Lobe blower

- Delivers superior cfm production reducing drying times and increasing water extraction capability.
- Dual oil bath splash lubrication design with sight level windows for reduced maintenance intervals and superior durability.
- Patented Tri-Lobe design for quiet operation and low pulsation
- Independent oil sumps prevent cross-contamination and allow the vacuum pump to operate safely on an incline
- Produces vacuum at 13" Hg and flows up to 455 CFM.



HydraMaster
We've Got Your Back



Made in the USA

www.hydramaster.com | 800.426.1301 | 425.775.7272

The Next Generation of Direct Drive Truckmounts

CDS xDRIVE
ACCELERATED DRIVE SYSTEM

General Emperor HTXS Series High Performance Solution Pump

- 4.0gpm solution pump with smoother operating 3-stage plunger design
- Operator adjustable pressure from 0 to 1200 psi
- Last step chemical pulse pump/chemical injection means no chemicals pass through the water pump or heat exchangers
- Electric clutch controlled for smooth solution delivery
- Uses patented “high-tech” packings for increased reliability and longevity along with nickel plated valve plugs and manifold
- Specifically designed for the rigorous on-off flow cycles and higher ambient temperatures on a truckmount



HydraMaster
We've Got Your Back



Made in the USA

www.hydramaster.com | 800.426.1301 | 425.775.7272

The Next Generation of Direct Drive Truckmounts

CDS xDRIVE
ACCELERATED DRIVE SYSTEM

Specifications/Performance Ratings

	CFM		Vacuum		Solution Temperature		Solution Pressure*	Fuel Consumption	Kilowatts		Wands
	Max	Average	Max	Average	Max	Average			Max	Average	
BOOST	456	369	14" Hg	12" Hg	240°F	210-220°F	0 to 1,200 PSI	1.95 GPH ↑ ↓ 1.48 GPH	14.5	12.7	Dual
HIGH	424	337	14" Hg	12" Hg	240°F	210-220°F			13.4	11.9	Dual
MID	392	305	14" Hg	12" Hg	230°F	210-220°F			12.6	11.1	Single
ECONOMY FUEL SAVER	360	286	14" Hg	10" Hg	220°F	200-220°F			11.6	9.1	Single

*Economy setting not recommended for hard surface cleaning

HydraMaster
We've Got Your Back



Made in the USA

www.hydramaster.com | 800.426.1301 | 425.775.7272

The Next Generation of Direct Drive Truckmounts

CDS xDRIVE
ACCELERATED DRIVE SYSTEM

Engineered for Performance - Adopts time tested, proven technology from the CDS 4.8 Overdrive with Salsa for superior reliability, longevity, and heat performance

Advantages of a Direct Drive Truckmount

- Safe and secure quieter operation. Ability to close doors during operation. Protects internal contents from weather exposure. Quiet operation allows for nighttime commercial cleaning and restoration work.

Smallest footprint in the industry. Compact, space saving design allows for flexibility in van set up. Perfect for hauling restoration equipment (airmovers, dehumidifiers, directed heat), power wands, RX20 NEXTGEN rotary jet extraction wand, EVOLUTION RX12 rotary hard surface tools, chemical solutions ,upholstery tools, hauling rugs and furniture and more



HydraMaster
We've Got Your Back



Made in the USA

www.hydramaster.com | 800.426.1301 | 425.775.7272

CDS xDRIVE

XCELERATED DRIVE SYSTEM

ISSA
INNOVATION
AWARD



HydraMaster
We've Got Your Back



Made in the USA

www.hydramaster.com | 800.426.1301 | 425.775.7272

CDS xDRIVE

XCELERATED DRIVE SYSTEM

We feel honored to be part of something as great as the HydraMaster CDS xDRIVE!

The X-Drive has served us faithfully and powerfully. We really like the entire setup and all the engineering that you all have put into it.

Here are some photos of our van. We had the van insulated with spray foam and the walls covered in 1/2" plywood. Don't miss the "rainbow" cutout allowing for the recovery tank lid to open!



Jordan Flory
Clean and Restore



ISSA
INNOVATION
AWARD

HydraMaster
We've Got Your Back



Made in the USA

www.hydramaster.com | 800.426.1301 | 425.775.7272

CDS xDRIVE

ACCELERATED DRIVE SYSTEM

We have now operated our CDS xDrive for about 300 system hours, and I must say we are thrilled with the truck mount. Its quiet, its efficient, and incredibly powerful. In fact since switching from our previous Butler System, the cost savings from maintenance and fuel (40% decrease!) alone is paying for this van right now. We will be buying another one this year, and expect to continue to add more of these systems to our fleet. Thank you HydraMaster for turning us on to this new technology.

Chris Wheeler



www.hydramaster.com | 800.426.1301 | 425.775.7272

Hi-Flow, Rotary, and EVOLUTION Laminar flow technology in tools and wands and why that matters.



www.hydramaster.com | 800.426.1301 | 425.775.7272

Evolution Wand Series

Rotationally Molded Delrin® Glide Wands and Tools



The #1 selling professional cleaning wand series in the world!

Now the full line of Evolution Wands and tools provide the professional cleaner and restorer with a wide range of problem solving and quick drying options whether using a truckmount or portable extractor, doing water damage and flood extraction, cleaning hard surface floors, or taking care of fine upholstery.



Better Cleaning, Faster Drying, Reduced Fatigue



www.hydramaster.com | 800.426.1301 | 425.775.7272

About the Evolution Wand Technology

HydraMaster took wand and tool design to the next level with the development of the technology with the Evolution Wand Series. Using a copolymer process to rotationally mold cleaning wands has resulted in tools that are lighter, more durable, and outperform traditional stainless steel wands and tools. Through scientific testing, the Evolution Wand series was designed to smooth airflow and boost water recovery performance. Side by side comparative testing of the 1.5" Evolution Wand against many of the other types of wands available resulted in 1/2 of the residual moisture per square foot, and has shown unmatched performance versus any other type of wand.



Better Cleaning, Faster Drying, Reduced Fatigue



www.hydramaster.com | 800.426.1301 | 425.775.7272

About the Evolution Wand Technology

The rotationally molded wand heads and aircraft aluminum tubes make the Evolution Wand Series nearly half the weight as comparable stainless steel wands and tools. Evolution wands and tools are custom fitted with a Delrin® acetyl glide with a glide holder that is molded or mounted to the wand or tool head for an airtight fit. Many aftermarket Teflon glides used on traditional wands are designed to fit a wide variety of tools and often don't fit well and slip and slide off. The Delrin® glides are especially matched to the glide holder on each Evolution Wand giving it an airtight seal and making it easily replaceable.



Better Cleaning, Faster Drying, Reduced Fatigue



www.hydramaster.com | 800.426.1301 | 425.775.7272

Evolution Wand Series

Rotationally Molded Delrin® Glide Wands and Tools

About the EVOLUTION Wand Series

HydraMaster took wand and tool design to the next level with the EVOLUTION Wand Series. By using a copolymer process to rotationally mold cleaning wands and handles our tools that are lighter, more durable, and outperform traditional wands and tools. Through scientific testing, the EVOLUTION Wand series was designed to smooth airflow and boost water recovery performance. The laminar airflow design improves airflow, increases extraction performance, and reduces drying time.



2" Titanium
16" head, 6-jet
000-163-054



2"
16" head, 6-jet
000-163-035



1.5"
13" head, 2-jet
000-163-034



2" Flood
Extraction -
16" head
000-163-058



1.5" Stair Wand
10" head, 1-jet
000-163-759



4" Glided
Upholstery Tool
000-163-617



Evolution RX12
000-163-790



Better Cleaning, Faster Drying, Reduced Fatigue



www.hydramaster.com | 800.426.1301 | 425.775.7272

1.5" Evolution Wand

Rotationally Molded Delrin Glide Carpet Cleaning Wand (13" head, 2 jet)

Half the Weight, Twice the Performance

- Rotationally molded to reduce weight and increase durability
- Laminar airflow design improves water recovery, increases extraction performance, and reduces drying time
- Laboratory tested to leave less residual moisture in the carpet
- Delrin glide holder is rotationally molded into the wand head for airtight fit and no slippage
- Designed to be used with both truckmounts and portable extractors (all jet sizes included)

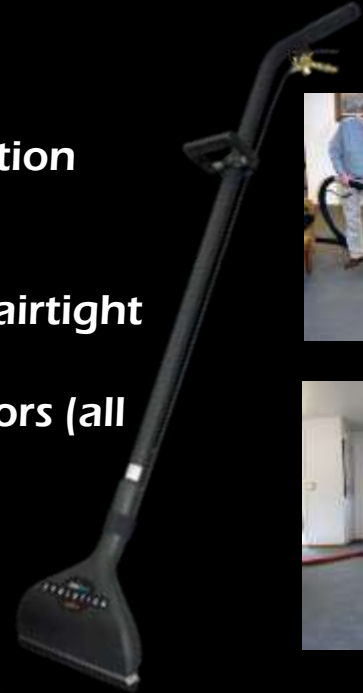

Part #000-163-034



HydraMaster
We've Got Your Back

Better Cleaning, Faster Drying, Reduced Fatigue



Made in the USA

www.hydramaster.com | 800.426.1301 | 425.775.7272

1.5" Evolution Wand

Rotationally Molded Delrin Glide Carpet Cleaning Wand (13" head, 2 jet)

Specifications: 1.5", 2-jet Evolution Wand (13")

- 13" head, 2 jet
- Weight: 6.5 lbs.
- Head: Roto-molded LLDPE
- Glide Receiver: 6061T6 aircraft aluminum
- Glide holder: Delrin – removable, replaceable
- Vacuum tube: 1.5" powder coated 6061 T6 aircraft aluminum
- Jets: (2) 110° #1 tips .8 GPM AT 500 psi
- Solution Line: 3000psi high pressure hose with stainless steel end fittings
- For 100-200 psi portables, use #001 jets (installed)
- For 200psi+ portables, and BOXXER 318, 318HP, 423S Truckmounts, use #002 jets (included)
- For BOXXER XL, Titan 575, 875 use #003 jets. (included)



Part #000-163-034



Better Cleaning, Faster Drying, Reduced Fatigue



www.hydramaster.com | 800.426.1301 | 425.775.7272

Part #000-163-034

2.0" Truckmount Evolution Wand

Rotationally Molded Delrin Glide Carpet Cleaning Wand (16" head, 6 jet)

2", 6-jet Evolution Truckmount Wand (16')

- Weight: 8.8 lbs.
- Head: 16" wide rotomolded head designed for laminar airflow
- Glide Receiver: 6061T6 aircraft aluminum
- Glide: Delrin – removable, replaceable
- Vacuum tube: 2" powder coated 6061 T6 aircraft aluminum
- Jets: (6) #1 tips (4-110 ° /2-95 ° on ends) - 1.75 GPM AT 500 psi
- Solution Line: Parker ¼" 3000psi high pressure hose with hydraulic swaged fittings
- Valve: Rated to 1200 psi
- Flow: At 500psi – 1.75 gallons per minute

Part #000-163-035



Better Cleaning, Faster Drying, Reduced Fatigue



www.hydramaster.com | 800.426.1301 | 425.775.7272

Part #000-163-034

2.0" Truckmount Evolution Wand

Rotationally Molded Delrin Glide Carpet Cleaning Wand (16" head, 6 jet)

Half the Weight, Twice the Performance

- Rotationally molded to reduce weight (only 8.8#) and increase durability
- Laminar airflow design improves airflow, increases extraction performance, and reduces drying time
- 2" diameter vacuum tube increases airflow for faster drying and fits perfectly to 2" vacuum hose without the need for reducing couplers that can limit performance
- 6 stainless steel spray jets are strategically placed on the stainless steel spray bar for maximum coverage, and the wide 16" cleaning head increase productivity by 30% over 1.5" wand



Better Cleaning, Faster Drying, Reduced Fatigue



www.hydramaster.com | 800.426.1301 | 425.775.7272

Part #000-163-034

Evolution Titanium 2" Wand

Rotationally Molded Head, Titanium Tube, Delrin Glide Carpet Cleaning Wand (16" head, 6 jet wand)

The lightest head and the lightest and most durable wand tube

- Designed for maximum corrosion resistance, yet 2lbs. lighter than a 2" stainless steel wand
- Flow control orifice keeps maximum control over flow and reduces clogging
- Durable, yet lightweight
- Titanium tube
- Rotationally molded to reduce weight and increase durability
- Laminar airflow design improves water recovery which increases extraction performance and reduces drying times



Part #000-163-054



Better Cleaning, Faster Drying, Reduced Fatigue



www.hydramaster.com | 800.426.1301 | 425.775.7272

Evolution Titanium 2" Wand

Rotationally Molded Head, Titanium Shaft, Delrin Glide Carpet Cleaning Wand (16" head, 6 jet wand)

Specifications

- **Weight:** 8.8 lbs.
- **Head:** 16" wide rotomolded head designed for laminar airflow
- **Glide holder:** 304 stainless steel
- **Glide:** Delrin – removable, replaceable custom airtight fit
- **Vacuum tube:** 2" powder coated Grade 2 Titanium
- **Stainless Steel jets:** (6) #1 tips (4-110° / 2-95° on ends)
- **Solution Line:** Parker 1/4" 3000psi high pressure hose with stainless steel end fittings
- **Valve:** Rated to 2500 psi
- **Flow:** At 500psi – 1.75 gallons per minute



Part #000-163-054



Made in the USA

www.hydramaster.com | 800.426.1301 | 425.775.7272

Evolution Flood Extraction Wand

Rotationally Molded Head, Delrin Glide Water Extraction Wand (16" head)

- The Aluminum tube and Rotomold head make it extremely lightweight helping reduce fatigue on the technician. The sealed Delrin® glides help push the wand across the carpet, and are tapered to keep a good seal on the fibers.
- No other tool has made such a dramatic increase in water recovery due to its laminar airflow design

Specifications

- Weight: 6.8 lbs.
- Head: 16" wide rotomold head designed for laminar airflow
- Glide Receiver: 6061T6 aircraft aluminum
- Glide: Delrin – removable, replaceable
- Vacuum tube: 2" powder coated 6061 T6 aircraft aluminum

Part Number: 000-163-058



www.hydramaster.com | 800.426.1301 | 425.775.7272

We've Got Your Back



Evolution Stair Wand

Rotationally Molded Head, Delrin Glide Wand for Stairs and Hard to Reach Places (10" head, 1-jet)

Lighter and more durable than stainless steel stair wands and tools

- Through scientific testing, the Evolution Stair Wand was designed to smooth airflow and boost water recovery performance. A rotationally molded head and aircraft aluminum tube make the Evolution Stair Wand lighter than most other stair wands or tools and more durable
- Ergonomically angled wand tube for fatigue reduction
- Laminar like airflow design improves airflow, increases extraction performance, and reduces drying time – leaves less residual moisture
- Delrin glide is mounted to the rotationally molded head for easy removal, clean-out, and replacement
- Brass check valve/stainless steel Inline filter with brass quick-connect prevents clogging and is easy to clean out
- 10" head with single jet spray application



Part #000-163-759



www.hydramaster.com | 800.426.1301 | 425.775.7272



Evolution Stair Wand

Rotationally Molded Head, Delrin Glide Wand for Stairs and Hard to Reach Places (10" head, 1-jet)

Specifications

- Weight: 4.5 lbs.
- Head: 10" Roto-molded LLDPE
- Glide: Delrin® – removable, replaceable
- Vacuum tube: 1.5" powder coated 6061 T6 aircraft aluminum
- Jet: 1 - #004 tip- 1.12gpm AT 500 psi
- Solution Line: High performance ¼" 3000psi high pressure hose with stainless steel end fittings
- Valve: Rated to 1000 psi (recommended usage 100 – 500psi)



Part #000-163-759



www.hydramaster.com | 800.426.1301 | 425.775.7272

Evolution Glided Upholstery Tool

Rotationally Molded Head, Delrin® Glided Upholstery Tool (4" head, shear angle single jet)

New to the Evolution line of cleaning tools for the cleaning and restoration professional and the cleaning contractor is the Evolution Glided Upholstery Tool. This durable, rotationally molded tool is lighter than conventional steel upholstery tools, reducing hand and wrist fatigue in upholstery cleaning. The Evolution Upholstery Tool was designed to smooth airflow and boost water recovery performance as compared to the harsh angles of a steel tool. Best of all, the glided head moves across the upholstery fabric better and increases water recovery.



Part #000-163-617



www.hydramaster.com | 800.426.1301 | 425.775.7272

Evolution Glided Upholstery Tool

Rotationally Molded Head, Delrin® Glided Upholstery Tool (4" head, shear angle single jet)

- The cleaning angle of the single jet shears across the fabric rather than directly down onto it greatly reducing your chances of over-wetting.
- Rotationally molded to reduce weight and increase durability
- Laminar like airflow design improves airflow, increases extraction performance, and reduces drying time.
- Ergonomically designed to reduce operator fatigue and ensure proper recovery when cleaning surfaces with unique geometry.
- Delrin glide is mounted to the rotationally molded tool head for airtight fit and no slippage
- Plastic glide is less likely to develop burrs than a steel tool head which could damage delicate upholstery fabrics. Also, glide can be replaced when worn



Part #000-163-617



Part #000-163-617 | www.hydramaster.com | 800.426.1301 | 425.775.7272

Evolution Glided Upholstery Tool

Rotationally Molded Head, Delrin® Glided Upholstery Tool (4" head, shear angle single jet)

Specifications

- Weight: 1.5#
- Head: 4" Roto-molded LLDPE
- Glide: Delrin® – removable, replaceable
- Jet: #002 tip
- Valve: Rated to 1200psi (Solution pressure of 40-80psi is recommended on upholstery)



NEW!



Part #000-163-617



Made in the USA

www.hydramaster.com | 800.426.1301 | 425.775.7272

NEW!

EVOLUTION RX12



**ROTARY
HARD SURFACE
EXTRACTION TOOL**



Introducing the newest member
of the EVOLUTION Wand Family



Made in the USA

www.hydramaster.com | 800.426.1301 | 425.775.7272
sales@hydramaster.com

NEW!

EVOLUTION RX12



**ROTARY
HARD SURFACE
EXTRACTION TOOL**



A better way to clean tile, stone, and concrete floors

The EVOLUTION RX12 ROTARY HARD SURFACE EXTRACTION TOOL allows you to deep clean tile, stone, and concrete floors faster, easier and better than any other cleaning tool or system. Combined with your truckmount or high performance - high pressure portable extractor, it will deep clean better and dry faster than any automatic or robotic scrubber on the market. Your ability to clean surfaces at higher solution pressures with rotary jet agitation, along with your capability to quickly recover wastewater and soiling and reduce drying time, make the EVOLUTION RX12 ROTARY HARD SURFACE EXTRACTION TOOL a better and more environmentally responsible way to clean hard surface floors.

Part# 000-163-790



Made in the USA

www.hydramaster.com | 800.426.1301 | 425.775.7272
sales@hydramaster.com

HydraMaster

NEW!

EVOLUTION RX12



**ROTARY
HARD SURFACE
EXTRACTION TOOL**



- A rotary washer and extraction tool that is driven by water pressure. It agitates, washes, and rinses the surface and immediately recovers the soil and water at the same time. It works best at solution pressures between 800-1200psi.
- Blasts soil, dirt and grime from tile, stone and concrete surfaces and brightens up grout lines. Cleans circles (pardon the pun) over any mop or automatic or robotic scrubber.
- The durable roto-molded handle is spaced average shoulder width apart for a smoother ergonomic cleaning that feels like the tool is floating across the floor. In addition, the robust rotomold design eliminates some of the flexing issues associated with other hard surface rotary extraction tools. The tool includes an easy access vacuum relief valve on the vacuum hose connection.
- Employs the highest quality, proven high speed Mosmatic DXG Swivel triple bearing system that is long lasting and maintenance free.
- Includes both a hard boot and brush ring for smooth or rough flooring surfaces, plus a 2" to 1.5" vacuum hose cuff adaptor for use with a high pressure portable.
- All hardware and fasteners are corrosion resistant.

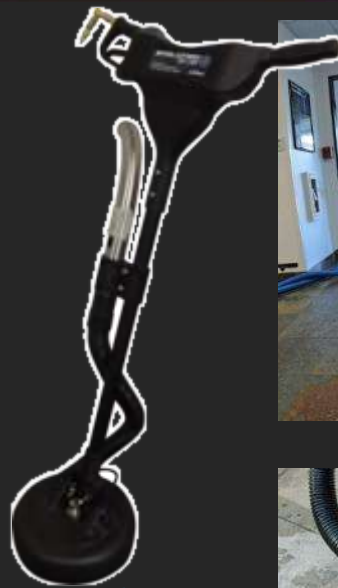

Made in the USA

www.hydramaster.com | 800.426.1301 | 425.775.7272
sales@hydramaster.com

HydraMaster

NEW! EVOLUTION RX12



ROTARY HARD SURFACE EXTRACTION TOOL

How does the tool work? - To really understand the power of the EVOLUTION RX12 ROTARY HARD SURFACE EXTRACTION TOOL you have to understand its cleaning action.

- It is a self-contained rotary washer and extractor, driven by water pressure. It agitates, washes and rinses the surface and immediately recovers the soil and water at the same time. It works best at solution pressures between 800-1200psi.
- Under the molded hood you will find a spray-bar and pressure-wash jets that are driven by water pressure. The EVOLUTION RX12 ROTARY HARD SURFACE EXTRACTION TOOL spins faster at higher pressures, and works with front-to-back and side-to-side motion.
- The durable handle has a 2" vacuum line all the way to the cleaning head for better air-flow and faster drying.
- The 12" cleaning path allows you to clean three times as fast as stationary hard surface wands. This saves you time, labor, and money!
- Low profile design allows the tool to get under counters



Made in the USA

www.hydramaster.com | 800.426.1301 | 425.775.7272
sales@hydramaster.com

HydraMaster
HydraMaster

NEW!

EVOLUTION RX12



ROTARY HARD SURFACE EXTRACTION TOOL



Thoughtful Design Leads to Better Performance

- The durable roto-molded handle is spaced average shoulder width apart for a smoother ergonomic cleaning that feels like the tool is floating across the floor. This design also allows the tool to work effectively for shorter or taller technicians
- The easy pull trigger helps reduce repetitive motion strain on muscles and tendons. Best of all the robust roto-mold design eliminates some of the flexing issues associated with other hard surface rotary extraction tools.
- The tool includes an easy access vacuum relief valve on the vacuum hose connection
- The heart of any rotary extraction tool is the swivel. We used the uppermost quality, proven high speed Mosmatic DXG Swivel triple bearing system that is long lasting and maintenance free. The corrosion resistant CERAMIC SEAL extends the life of your swivel.
- The EVOLUTION RX12 ROTARY HARD SURFACE EXTRACTION TOOL includes both a hard boot and brush ring for smooth or rough surfaces.
 - The attached brush ring is used for most surfaces. The brush bottom prevents trapping particles that could scratch soft floors, especially sensitive stone surfaces. The brush may also be preferred on very flat floors when the plastic body forms a tight seal making the tool harder to move.
 - The hard boot is typically used on harder surfaces. The plastic boot that contacts the floor assures good vacuum and a dry finish for most flat tile floors. To change from the attached brush to the hard boot, simply remove the four screws, dismount the ring or brush, insert the ring or brush, and tighten the four screws.



Made in the USA

Part # 000-163-790



Made in the USA

www.hydramaster.com | 800.426.1301 | 425.775.7272
sales@hydramaster.com





Evolution Wand Rack/Holder

Rugged and Durable ABS Plastic

Quit fumbling around in the back of your van or work vehicle trying to find the right place for your Evolution Wands. Those clips don't hold up and often don't fit, but you need to clear floor space and have a place where your technicians know the wand always goes. The Evolution Multi-Purpose Wand Rack/Holder is designed to provide a more professional look to your van, while simultaneously increasing your van organization and efficiency. It protects your wands, and all of the other contents of your van from damage being inflicted by falling wands.

1.5" Holder: Part #000-078-945

2.0" Holder: Part #000-078-946



www.hydramaster.com | 800.426.1301 | 425.775.7272



Evolution Wand Rack/Holder

Rugged and Durable ABS Plastic

Specifications

- **The Evolution Multi-Purpose Wand Rack** is manufactured with black durable ABS plastic that is corrosion resistant
- Comes in a 1.5" version and a 2" version. The 1.5" version is specifically designed to hold the 1.5 Evolution Wand or Evolution Stair Wand. It will also hold most standard stainless steel 1.5" wands and some 1.5" "S" Bend stainless steel wands. The 2" version is designed to hold the 2" Evolution Wand and the 2" Titanium Evolution Wand. It will also hold most standard stainless steel or Titanium 2.0" wands and some 2.0" "S" Bend stainless steel wands
- The auto-secure tensioner "locks" the wand in place so it will not fall out, even when making sudden stops or turning sharp corners
- Can be mounted either to the side of the van or the roof



1.5" Holder: Part #000-078-945

2.0" Holder: Part #000-078-946



www.hydramaster.com | 800.426.1301 | 425.775.7272



Evolution Wand Rack/Holder

Rugged and Durable ABS Plastic

Specifications

- Added slot will simultaneously store and hold a carpet grooming tool or rake (van side-mount only)
- 3 additional holes on the rack allow you to use bungee cords/wraps to store other hoses and accessories in place
- Standard kits come with two brackets
- Recommended mounting is directly to the rib of the van
- Two kits can be mounted on one wall to hold multiple wands



1.5" Holder: Part #000-078-945

2.0" Holder: Part #000-078-946



www.hydramaster.com | 800.426.1301 | 425.775.7272

Evolution Wand Series

Rotationally Molded Delrin® Glide Wands and Tools

About the EVOLUTION Wand Series

HydraMaster took wand and tool design to the next level with the EVOLUTION Wand Series. By using a copolymer process to rotationally mold cleaning wands and handles our tools that are lighter, more durable, and outperform traditional wands and tools. Through scientific testing, the EVOLUTION Wand series was designed to smooth airflow and boost water recovery performance. The laminar airflow design improves airflow, increases extraction performance, and reduces drying time.



2" Titanium
16" head, 6-jet
000-163-054



2"
16" head, 6-jet
000-163-035



1.5"
13" head, 2-jet
000-163-034



2" Flood
Extraction -
16" head
000-163-058



1.5" Stair Wand
10" head, 1-jet
000-163-759



4" Glided
Upholstery Tool
000-163-617



Evolution RX12
000-163-790



Better Cleaning, Faster Drying, Reduced Fatigue



www.hydramaster.com | 800.426.1301 | 425.775.7272

The most well thought out ergonomic design of any upholstery tool in the industry.

driMASTER³

No repetitive motion strain or syndrome here!
driMASTER 3 Upholstery Cleaning Tool

- Continuous hi-flow jetless cleaning technology for better productivity and faster cleaning.
- Shearing effect and innovative vacuum design virtually eliminates the most common cause of upholstery cleaning problems - overwetting.
- Molded glides on the tool lips allows for smoother, safer flow across even the most delicate fabrics.

TRIGGER VALVE



HydraMaster
We've Got Your Back



Made in the USA

www.hydramaster.com | 800.426.1301 | 425.775.7272

DriMaster 3 Upholstery Cleaning Tool

Hi-Flow Hyper-Velocity Jetless Cleaning Technology

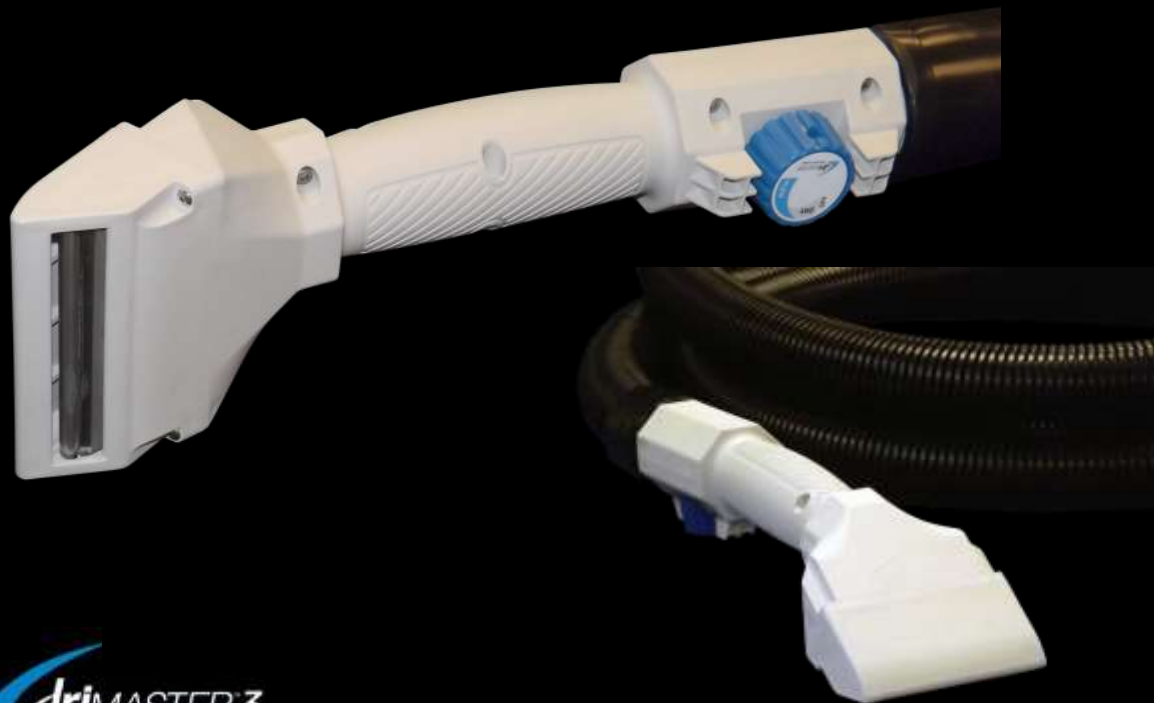

driMASTER 3

HydraMaster
We've Got Your Back



Made in the USA

www.hydramaster.com | 800.426.1301 | 425.775.7272

DriMaster 3 Upholstery Cleaning Tool

Hi-Flow Hyper-Velocity Jetless Cleaning Technology

The problem with conventional upholstery cleaning tools

- Cleaning upholstery fabrics with conventional tools has traditionally meant the technician had to bypass the power of their cleaning equipment rather than taking advantage of it
- To avoid spraying water too deep into the upholstery and causing overwetting, the technician had to reduce their solution flow and their solution pressure
- With extreme soiling, multiple wet passes would mean soaking and overwetting the fabric and the cushion behind it, leading to slower cleaning and increased potential for fabric bleeding, browning, and shrinkage



www.hydramaster.com | 800.426.1301 | 425.775.7272

DriMaster 3 Upholstery Cleaning Tool

Hi-Flow Hyper-Velocity Jetless Cleaning Technology

The problem with conventional upholstery cleaning tools

- Plus, as the solution dripped from the tool or gathered at the end of the tool pass, it was easy for streaking to occur
- The low solution pressure and water flow rates will often not activate the heating functions of your truckmount, meaning that you are forced to clean with lukewarm water or too scalding hot of water



www.hydramaster.com | 800.426.1301 | 425.775.7272

DriMaster 3 Upholstery Cleaning Tool

Hi-Flow Hyper-Velocity Jetless Cleaning Technology

Hi-Flow Hyper-Velocity Jetless Cleaning Technology

Virtually eliminates the most common cause of upholstery cleaning problems, overwetting – helping you greatly reduce the chances of bleeding, shrinking, and browning



www.hydramaster.com | 800.426.1301 | 425.775.7272

DriMaster 3 Upholstery Cleaning Tool

Hi-Flow Hyper-Velocity Jetless Cleaning Technology

Hi-Flow, Hyper-Velocity fluid stream technology

Allows you to utilize the power of your truckmount or high performance portable extractor rather than by-passing it and keeps your truckmount heating system operating throughout the cleaning

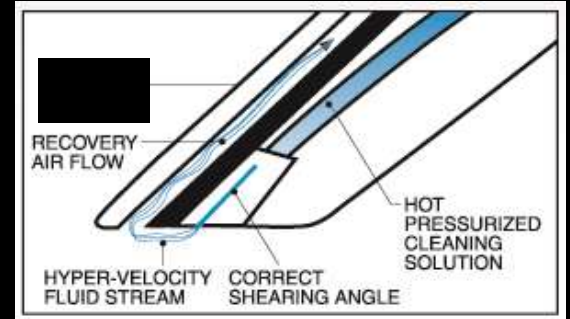

driMASTER 3

HydraMaster
We've Got Your Back



Made in the USA

www.hydramaster.com | 800.426.1301 | 425.775.7272

DriMaster 3 Upholstery Cleaning Tool

Hi-Flow Hyper-Velocity Jetless Cleaning Technology

Solution is applied in thin, flat hyper-velocity fluid stream for even application. The constant solution flow is trained by the patented injector bar and slotted vacuum port system. The cleaning solution shears across the fabric, rather than directly spraying into it, which greatly minimizes the likelihood of over-wetting the fabric. Plus, the immediate vacuum recovery of solution flow means less residual moisture

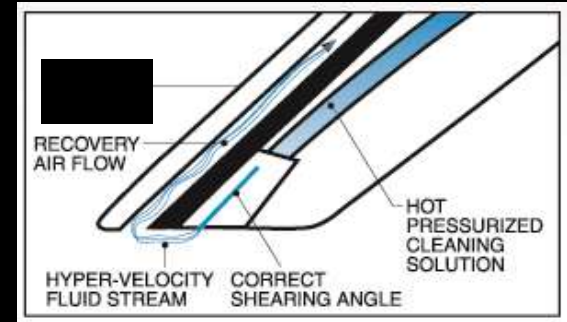

www.hydramaster.com | 800.426.1301 | 425.775.7272

DriMaster 3 Upholstery Cleaning Tool

Hi-Flow Hyper-Velocity Jetless Cleaning Technology

- Faster cleaning means more money for you, less fatiguing means you can clean upholstery in volume.
- Leaves the fabric cleaner and dryer
- 20% larger cleaning head means faster cleaning than the competitive upholstery tools
- No carpal tunnel syndrome here - Jetless, no trigger valve technology for less hand strain
- No heat loss from atomizing

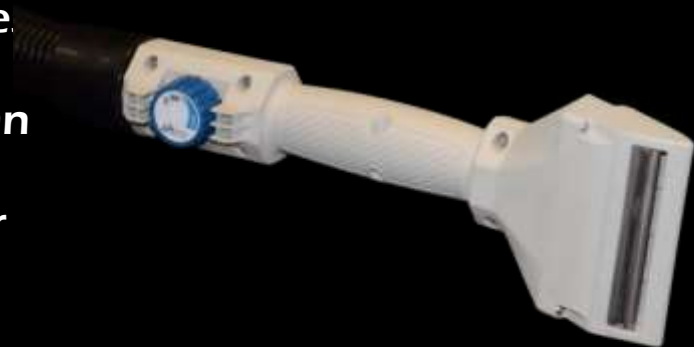

www.hydramaster.com | 800.426.1301 | 425.775.7272

DriMaster 3 Upholstery Cleaning Tool

Hi-Flow Hyper-Velocity Jetless Cleaning Technology

3rd Generation Enhancements

Molded glide lips means a smoother surface with nothing to wear out virtually eliminating any chance of fabric snagging

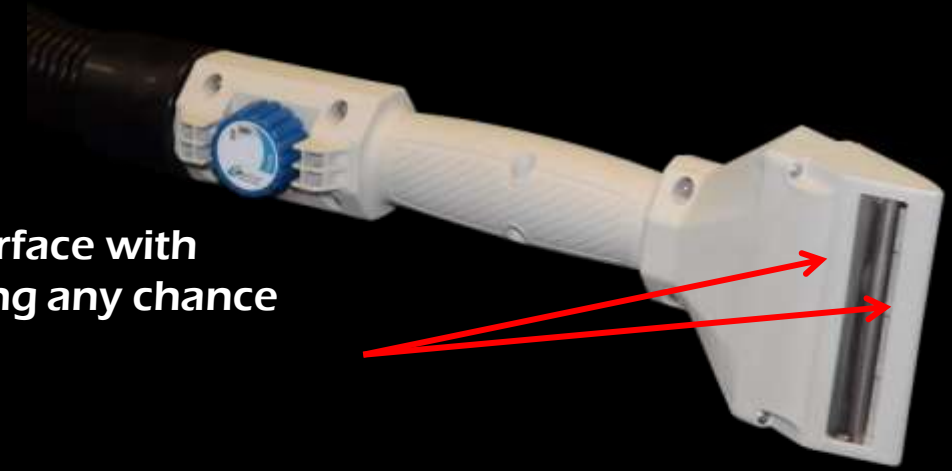

www.hydramaster.com | 800.426.1301 | 425.775.7272

DriMaster 3 Upholstery Cleaning Tool

Hi-Flow Hyper-Velocity Jetless Cleaning Technology

3rd Generation Enhancements

The tool is easy to clean out and even easier to service!
Just undo four screws and remove the nose cone for complete access. Push to connect fittings between the valve and bar jet allow for cleaning access and easy replacement.

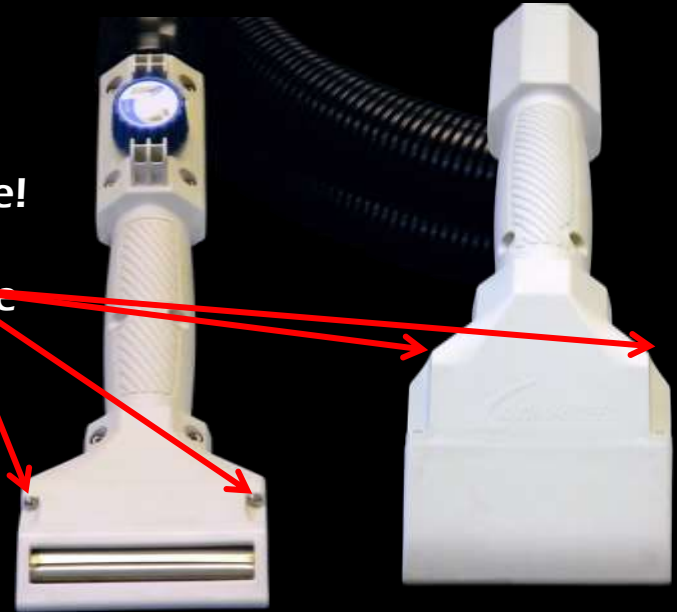

www.hydramaster.com | 800.426.1301 | 425.775.7272

DriMaster 3 Upholstery Cleaning Tool

Hi-Flow Hyper-Velocity Jetless Cleaning Technology

3rd Generation Enhancements

If nose cone gets dropped, cracked or chipped, just replace the nose cone. This extends the useful life of your tool for long term profitable cleaning.

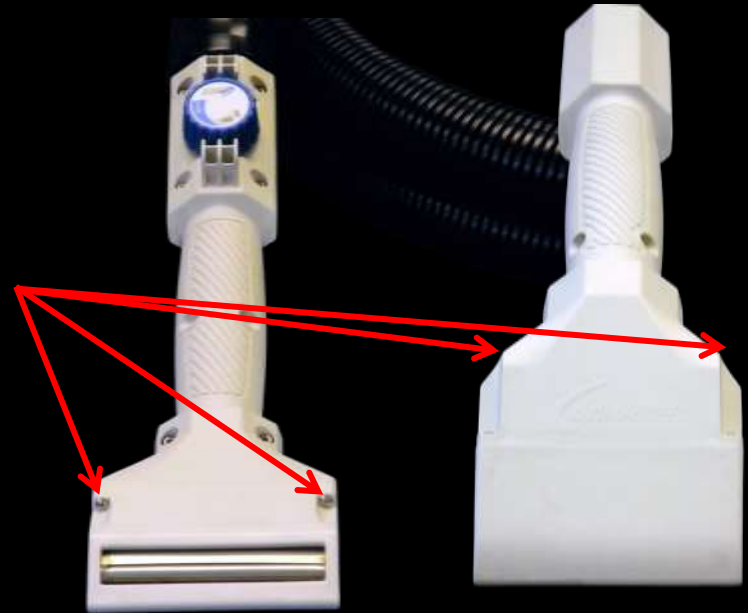

www.hydramaster.com | 800.426.1301 | 425.775.7272

DriMaster 3 Upholstery Cleaning Tool

Hi-Flow Hyper-Velocity Jetless Cleaning Technology

A perfect spot and stain removal tool for oriental rugs – flushes through the rug for better removal without overwetting!



Made in the USA

www.hydramaster.com | 800.426.1301 | 425.775.7272

DriMaster 3 Upholstery Cleaning Tool

Hi-Flow Hyper-Velocity Jetless Cleaning Technology

Also the ideal high productivity tool for office partitions (cubicle) cleaning – safe and effective - better soil removal without overwetting!



Made in the USA

www.hydramaster.com | 800.426.1301 | 425.775.7272



RX20

NEXT GEN



The Stakes Have Been Raised...



NEW!

HydraMaster
We've Got Your Back



Made in the USA



www.hydramaster.com | 800.426.1301 | 425.775.7272

RX20 NEXTGEN Rotary Jet Extraction® Cleaning Wand



The Stakes Have Been Raised...

The RX20 set the standard for Rotary Jet Extraction® cleaning, with over 25,500 units sold over the last 36 years. Now, the New RX20 **NEXTGEN** Rotary Jet Extraction® Tool redefines that standard and “ups the ante.”



Made in the USA

www.hydramaster.com | 800.426.1301 | 425.775.7272

RX20 NEXTGEN Rotary Jet Extraction® Cleaning Wand



Easier to handle, more comfortable to operate

- Additional momentary switch sustains head rotation and allows user to operate with left hand only
- Additional lower rear carry handle

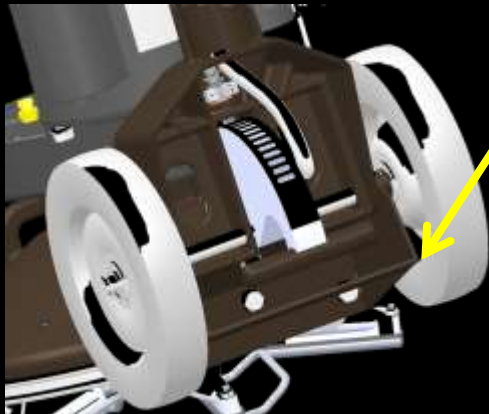

RX20 NEXTGEN Rotary Jet Extraction® Cleaning Wand

Easier to handle, more comfortable to operate

- No slip handle locking mechanism is easier to use and self locking– tee handle, spring pull, latches with positive locks at 5-7 degree increments

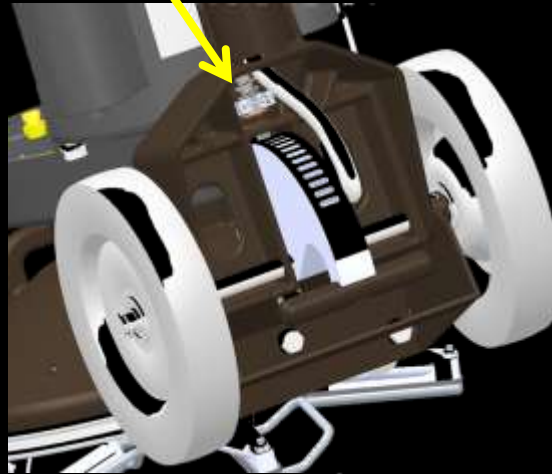

Made in the USA

www.hydramaster.com | 800.426.1301 | 425.775.7272

RX20 NEXTGEN Rotary Jet Extraction® Cleaning Wand



New feature extends your cleaning reach, optimizes productivity

- On-board crevice tool with robust design and storage bracket increases your cleaning reach and allows for uninterrupted deep cleaning/vacuuming of edges and corners
The customer and technician can see the soil being extracted through the clear tube



Made in the USA

www.hydramaster.com | 800.426.1301 | 425.775.7272

RX20 NEXTGEN Rotary Jet Extraction® Cleaning Wand

Less fatiguing, operate longer

- Comfortable re-designed ergonomic operator handle
- Handle angle positioned for comfort and productivity (15 degrees up, 10.5 degrees back)



Made in the USA

www.hydramaster.com | 800.426.1301 | 425.775.7272

RX20 NEXTGEN Rotary Jet Extraction® Cleaning Wand



Enhanced engineering design reduces complexity, easier to train technicians

- Redesigned and enhanced label artwork and color graphics provide detailed operation instructions right on the handle
- Smooth wheels help prevent picking up debris during transport

Quick Operation Guide

1 [Power Button] 2 [Spray Trigger]

RX20 Maintenance Schedule

Start of Day	End of Day	Periodic
1 Place a lubricated felt gasket in cleaning head	1 Clean bell housing, cleaning head, and Powerhead body	1 Monthly - check oil level in gear box and inspect for leaks
2 Lubricate drive shaft and install cleaning head	2 Flush jets	2 Monthly - check skids and weldments, replace if needed
3 Check jets on cleaning head	3 Remove felt gasket and place in lubricating oil	3 6 Months - under the bell housing check felt gasket plate seal for wear
		4 6 Months - Change oil in gear box

RX20 NEXT GEN
HydraMaster



RX20 NEXT GEN

HydraMaster
We've Got Your Back



Made in the USA

www.hydrmaster.com | 800.426.1301 | 425.775.7272

RX20 NEXTGEN Rotary Jet Extraction® Cleaning Wand



Streamlined manufacturing practices

- Reduction in number of parts, and more of the mechanisms built into the cast and molded handle
- 35 years of accumulated knowledge in manufacturing resulted in improved processes and designs



RX20
NEXT GEN

HydraMaster
We've Got Your Back



Made in the USA

www.hydramaster.com | 800.426.1301 | 425.775.7272

RX20 NEXTGEN Rotary Jet Extraction® Cleaning Wand

Contractor Price: \$3,095



RX20
NEXT GEN

HydraMaster
We've Got Your Back



Made in the USA

www.hydramaster.com | 800.426.1301 | 425.775.7272

RX20 NEXTGEN Rotary Jet Extraction® Cleaning Wand

- The RX20 NextGen Rotary Jet Extractor® continues to revolutionize the way professional cleaners and restorers deep clean carpets.
- It cleans the carpet fiber from five different angles. With three spray jets matched with 5 vacuum slots that are independently suspended by a flexible spring arm, the RX20 NextGen makes over 650 cleaning passes per minute. This super agitation, combined with the unit's weight cleans a carpet deeper, extracting soil and cleaning solution.



RX20
NEXT GEN

HydraMaster
We've Got Your Back



Made in the USA

www.hydramaster.com | 800.426.1301 | 425.775.7272

RX20 NEXTGEN Rotary Jet Extraction® Cleaning Wand

- The rotating head cleans all sides of the carpet fiber, fluffing up and restoring the pile. The cleaning head floats and glides across the carpet. The self-propelled RX20 NextGen glides over the carpet; the rotary action of the cleaning head does all the work. The RX20 NextGen sweeps back and forth with just a slight change of balance on the handle. The effort needed to use an RX20 NextGen is a fraction of that used scrubbing back and forth with a wand.
- Best of all, the extraction recovery performance of the RX20 NextGen dries the carpet faster than ever. The results are astounding, especially on extremely soiled, matted carpet.



RX20
NEXT GEN

HydraMaster
We've Got Your Back



Made in the USA

www.hydramaster.com | 800.426.1301 | 425.775.7272

RX20 NEXTGEN Rotary Jet Extraction® Cleaning Wand

- The RX20 NextGen delivers consistent results all day long and is not operator dependent. Using a rotary jet extractor often means you'll be cleaning at the same quick pace at the end of the day as when you started; consistent effort that translates into consistent quality and happy customers.
- Customers will be impressed by the high-tech approach to cleaning that the RX20 NextGen provides, setting your cleaning company apart from those that use a conventional scrub or drag wand. Experience has shown this to be true as repeat customers often call specifically requesting the rotary extraction of an RX20 NextGen.



RX20
NEXT GEN

HydraMaster
We've Got Your Back



Made in the USA

www.hydramaster.com | 800.426.1301 | 425.775.7272

RX20 NEXTGEN Rotary Jet Extraction® Cleaning Wand

"It is like that famous battery bunny. It just keeps going and going and going. It does not tire out even after I have, which means I clean consistently the same way throughout the job and day"
Bruce D.



RX20
NEXT GEN

HydraMaster
We've Got Your Back



Made in the USA

www.hydrmaster.com | 800.426.1301 | 425.775.7272

RX20 NEXTGEN Rotary Jet Extraction® Cleaning Wand

Now the RX20 NEXTGEN is available in a version that is optimized for use with high performance portable extractors - Part # 700-041-334

You can use this special version of the RX20 NEXTGEN with a high performance portable extractor like the PEX 500, the HydraPort 400 or 1200 psi model, or the King Cobra 1200 Pro. It comes down to the air flow needs of your extractor matching up best with the rotary tool.

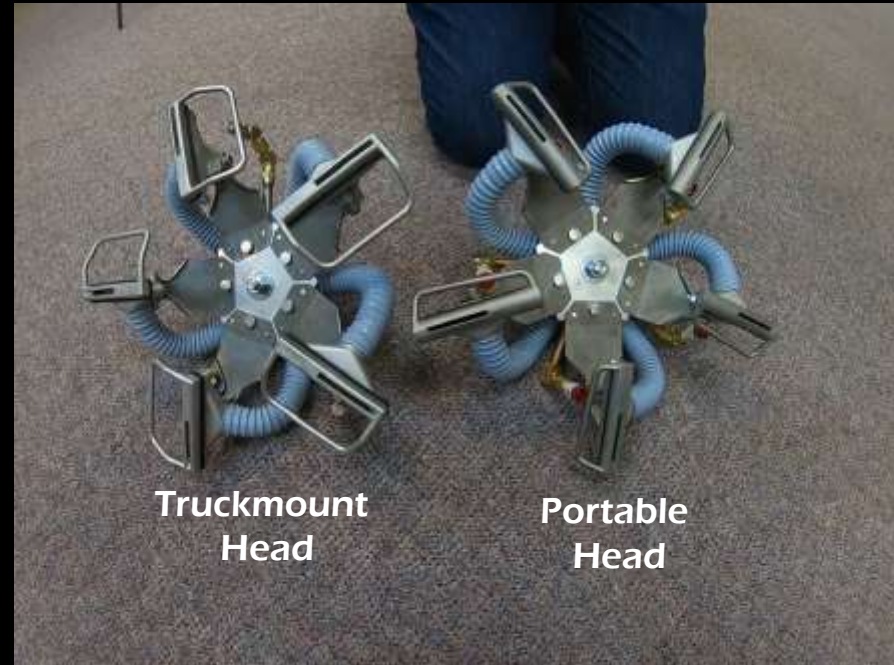

RX20
NEXT GEN

HydraMaster
We've Got Your Back



Made in the USA

www.hydramaster.com | 800.426.1301 | 425.775.7272

RX20 NEXTGEN Rotary Jet Extraction® Cleaning Wand

Now the RX20 NEXTGEN is available in a version that is optimized for use with high performance portable extractors - Part # 700-041-334

- HydraMaster has changed with jets and skids on this special model. The jets allow the standard volume of water to flow onto the carpet, but the genius part is the skids are designed specifically for lower air flow (that portables need) and optimized for the best recovery.
- There are five smaller quick connect jets on the portable version of the RX20 NEXTGEN that are designed to complement the portable version of the stainless skids that allow for optimizing the lesser vacuum you see out of portables.

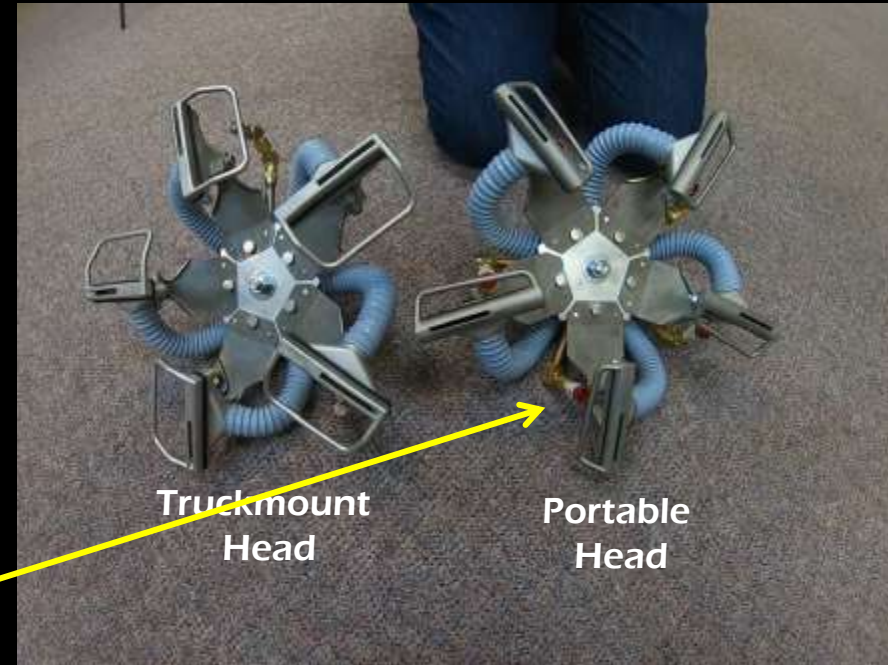

RX20
NEXT GEN

HydraMaster
We've Got Your Back



Made in the USA

www.hydramaster.com | 800.426.1301 | 425.775.7272

RX20 NEXTGEN Rotary Jet Extraction® Cleaning Wand

Now the RX20 NEXTGEN is available in a version that is optimized for use with high performance portable extractors - Part # 700-041-334

- Special angles on the skids have been demonstrated to enhance water recovery with the less vacuum flow of a portable extractor.
- In addition, the opening of the vacuum orifice on the skid is smaller for the portable version
- The special skids and supporting jets are designed to optimize water recovery with a portable extractor and reduce drying times.

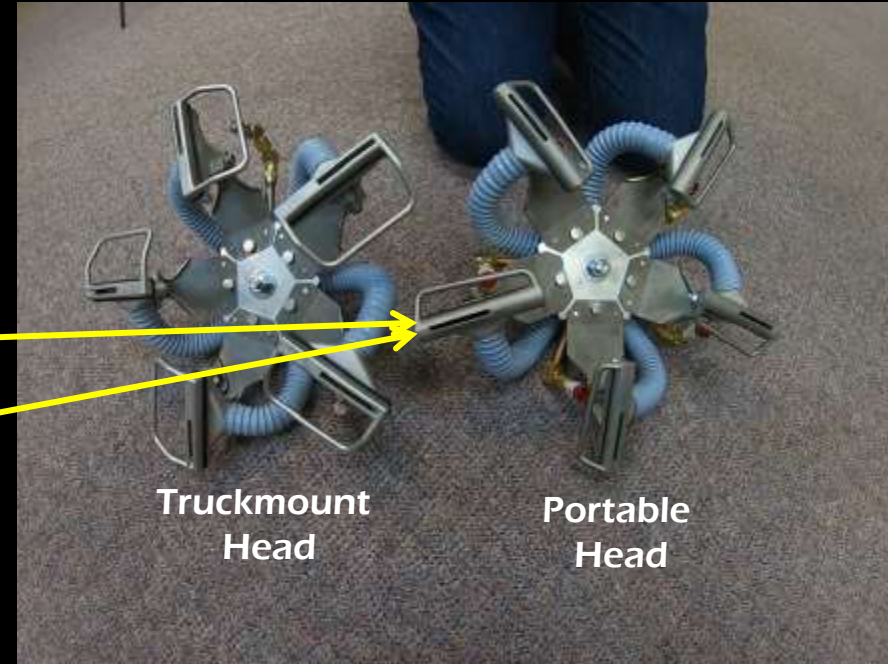

RX20
NEXT GEN

HydraMaster
We've Got Your Back



Made in the USA

www.hydrmaster.com | 800.426.1301 | 425.775.7272

RX20 NEXTGEN Rotary Jet Extraction® Cleaning Wand

Now the RX20 NEXTGEN is available in a version that is optimized for use with high performance portable extractors - Part # 700-041-334

- The RX20 NEXTGEN portable version works best with portable extractors producing 400psi or more in solution pressure



RX20
NEXT GEN

HydraMaster
We've Got Your Back



Made in the USA

www.hydramaster.com | 800.426.1301 | 425.775.7272

RX20 NEXTGEN Rotary Jet Extraction® Cleaning Wand

**The RX20 is not just a carpet extraction tool...
An often overlooked gem for water extraction during
water damage restoration**

- An independent water extraction test by a leading trade association demonstrated that heavier rotary extraction wands like the RX20 NextGen did a better job at extracting water from glue down carpets than many wands specifically designed for water extraction only
- In fact, even on residential style carpet the RX20 outperformed many so called dedicated extraction wands at water recovery from a flooded carpet.
- Multiple passes of head across the carpet ensures a higher level of water extraction and faster drying.
- Finally, just like in cleaning, when using the RX20 NextGen for water extraction, it reduces fatigue, and keeps up maximum extraction even when the restoration technician is worn out.



RX20
NEXT GEN

HydraMaster
We've Got Your Back



Made in the USA

www.hydramaster.com | 800.426.1301 | 425.775.7272

RX20 NEXTGEN Rotary Jet Extraction® Cleaning Wand

The RX20 is not just a carpet extraction tool...

**Low moisture carpet cleaning – bonnet or encapsulation
RX Pad and Bonnet Driver - This attachment allows the RX to
quickly convert to drive carpet cleaning bonnet pads
Part No. 190-041-024**

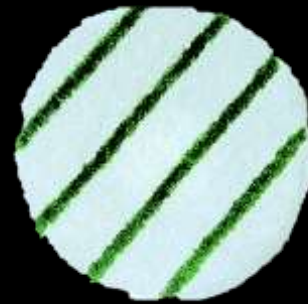

www.hydramaster.com | 800.426.1301 | 425.775.7272

RX20 NEXTGEN Rotary Jet Extraction® Cleaning Wand

The RX20 is not just a carpet extraction tool...

Hard surface floor deep cleaning, stripping, or scrubbing – luxury vinyl tile, ceramic or porcelain tile, natural stone, and finished concrete

RX Hard Floor Attachment - LD

Suitable for Light Duty (LD) scrubbing of vinyl, terrazzo, slate and marble surfaces. The brush on this attachment replaces red pads. Part No. 190-041-024

RX Hard Floor Attachment – MD Suitable for Medium Duty (MD) to aggressive scrubbing and stripping of resilient floors, terrazzo, quarry tile and concrete floors. The brush on this attachment replaces brown and black pads and will outlast them more than 100 to 1.

Part No. 190-041-025

RX Hard Floor Attachment – HD Designed for Heavy Duty (HD) to most aggressive stripping and scrubbing of resilient floors, terrazzo, quarry tile and concrete floors. The brush on this attachment replaces high productivity pads.

Part No. 190-041-025

RX20
NEXT GEN



Made in the USA

www.hydrmaster.com | 800.426.1301 | 425.775.7272

RX20 NEXTGEN Rotary Jet Extraction® Cleaning Wand

But don't just take our word for it. Listen to what the legion of RX20 owners and fans have to say:
I have used the RX20 for as long as I could remember. When I was 3-6 years old my dad would have me sit on the motor for extra weight, we ended up burning up a motor. I use it on 90% of my jobs commercial and residential.

VS Restoration Carpet Cleaning

I've used a RX20 for 10 years on every single job and love it.

Jeff Galley



RX20
NEXT GEN

HydraMaster
We've Got Your Back



Made in the USA

www.hydramaster.com | 800.426.1301 | 425.775.7272

RX20 NEXTGEN Rotary Jet Extraction® Cleaning Wand

But don't just take our word for it. Listen to what the legion of RX20 owners and fans have to say:

I have been using one [RX20] since I was a kid helping my dad, we use them on probably 99.9% of our jobs , it has also become one of our main marketing tools, seeing that hardly no one else in our area uses a rotary of any kind! The funny thing is that I have met other so called professionals in our area (with 25 years plus experience , so says their ads) who have never seen such a thing! We've been using them for 15 plus years definitely our best investment!

Marty J



RX20
NEXT GEN

HydraMaster
We've Got Your Back



Made in the USA

www.hydramaster.com | 800.426.1301 | 425.775.7272

RX20 NEXTGEN Rotary Jet Extraction® Cleaning Wand

But don't just take our word for it. Listen to what the legion of RX20 owners and fans have to say:

Especially in this current market the RX20 sets a standard that not all service providers can match. Those who are not the top of the food chain will be eliminated. My RX20 allows me out perform other competitors.

Anthony Wynkoop

The RX20 does a great job cleaning carpet. ... I have a lot of customers that think the only thing that can get their carpet clean is the RX20.

Alpine Professional Carpet Care



RX20
NEXT GEN

HydraMaster
We've Got Your Back



Made in the USA

www.hydramaster.com | 800.426.1301 | 425.775.7272

RX20 NEXTGEN Rotary Jet Extraction® Cleaning Wand

But don't just take our word for it. Listen to what the legion of RX20 owners and fans have to say:

Heavily soiled carpets are really where the RX-20 shines. As far as I'm concerned the RX20 really comes in handy as far as making a pretty hard job a lot easier.
Extremeclean

We use the RX20 on everything. It will set you apart from your competition for sure!
All American Carpet Cleaning, Branson MO

I've had 5 Rx's different models ... The RX is almost bulletproof.
Paul Brown



RX20
NEXT GEN

HydraMaster
We've Got Your Back



Made in the USA

www.hydramaster.com | 800.426.1301 | 425.775.7272

RX20 NEXTGEN Rotary Jet Extraction® Cleaning Wand

But don't just take our word for it. Listen to what the legion of RX20 owners and fans have to say:

The RX20 has a track record of I believe more than 15 or 20 years doing great for commercial applications.

CE Carpet Care, Torrance, CA

The RX20 is an awesome machine I plan to buy down the road. I used one frequently at my old job and loved it.

Todd's Carpet and Tile, Las Vegas, NV

I use my RX20 on everything I love it
Spectrum Floor Cleaning



RX20
NEXT GEN

HydraMaster
We've Got Your Back



Made in the USA

www.hydramaster.com | 800.426.1301 | 425.775.7272

RX20 NEXTGEN Rotary Jet Extraction® Cleaning Wand

We asked professional cleaners and restorers what kind of jobs they would never try to do without their RX20?

I just did a 20,000 square foot building in Washington DC, 10 floors with the Titan and the RX20. Of course the customer was amazed.

Ryan G.

The RX20 is an awesome tool for making carpet very clean....Love it!

Brian H.

EVERY SINGLE CUT PILE CARPET I HAVE EVER DONE!

Love that machine!

Joseph R.



RX20
NEXT GEN

HydraMaster
We've Got Your Back



Made in the USA

www.hydramaster.com | 800.426.1301 | 425.775.7272

RX20 NEXTGEN Rotary Jet Extraction® Cleaning Wand

We asked professional cleaners and restorers what kind of jobs they would never try to do without their RX-20?

All of them!
Jeff G.

Three story court house in Tupelo, Mississippi – Elvis's birth place. Used my Boxxer and my RX20 and did an unbelievable job. I love my machine and my RX20.
Stephen H.

Long hallways in a retirement center. Well truthfully, all our jobs!
Ed H.



RX20
NEXT GEN

HydraMaster
We've Got Your Back



Made in the USA

www.hydramaster.com | 800.426.1301 | 425.775.7272

RX20 NEXTGEN Rotary Jet Extraction® Cleaning Wand

We asked professional cleaners and restorers what kind of jobs they would never try to do without their RX-20?

I clean some nasty, trashed apartment carpets. Without my RX20 I would be screwed!

Mark V.

The RX20 is the best!

Gustavo B.

Too many to count or name. Best was a pub and a brewery.

Matt H.

Every job!

Shawn M.



RX20
NEXT GEN

HydraMaster
We've Got Your Back



Made in the USA

www.hydramaster.com | 800.426.1301 | 425.775.7272

RX20 NEXTGEN Rotary Jet Extraction® Cleaning Wand

We asked professional cleaners and restorers what kind of jobs they would never try to do without their RX20?

The RX20 is a lifesaver. There is no way I would clean commercial carpet or large jobs without it. Great piece of equipment!

John B.

Every job I do!

Matt H.

Every job, every day!

Randy G.

Large carpeted gymnasium.

Larry H



RX20
NEXT GEN

HydraMaster
We've Got Your Back



Made in the USA

www.hydramaster.com | 800.426.1301 | 425.775.7272

RX20 NEXTGEN Rotary Jet Extraction® Cleaning Wand

**We asked professional cleaners and restorers
what kind of jobs they would never try to do
without their RX20?**

Nightclubs and bars. It just cuts through the crud!
Allan S.

Hospital in Baltimore, Maryland.
John B.



RX20
NEXT GEN

HydraMaster
We've Got Your Back



Made in the USA

www.hydramaster.com | 800.426.1301 | 425.775.7272